

GTM II

user and operating manual

Function of the keys

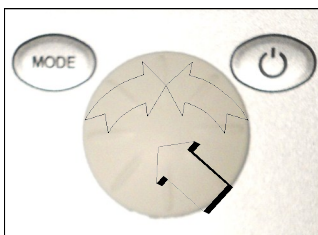

122 x 70 x 35 mm



System ON

Press the **ON/OFF** key until the display is turned on.

System OFF

Press the **ON/OFF** key for 2 sec. (standby).

Display OFF

When the system is in Standby, press the **ON/OFF** key until the display is turned off.

1. Hand (manual)

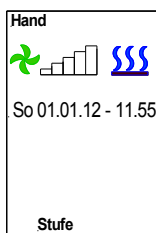

If the **Stufe (settings)** option is displayed in the bottom line, you can set different fan settings by turning the multifunctional rotary knob. If you press the multifunctional rotary knob, the **Heizung (heating)** option will be displayed. Depending on the programming (see point 5 **Setting 0 MV**), the optional solenoid valve can be turned on or off by turning the multifunctional rotary knob.

Set the **Manual** operation (if required).

Press the **Mode** key (**PGM Mode** display). Select **Hand (manual)** by using the multifunctional rotary knob (the text colour will change from orange to black). Press the knob to confirm the selection. **Hand** will be displayed on the top display line. Press the **MODE** key to activate the **Hand** operating mode.



Press the **Mode** key (**PGM Mode** display). Turn the multifunctional rotary knob to display the **Stufe (settings)** setting in the bottom line. Press the multifunctional rotary knob to confirm. Next, turn the knob to select a fan setting and press the knob to confirm the selection. The heating can be set in advance using the same method (**ON** = symbol colour **red**).

Again press the **MODE** key to activate the selected operational mode.
(Default setting: **fan setting 0**, **heating OFF** and symbol colour **blue**)

2. AutoTK (automatic operation with door contact control)

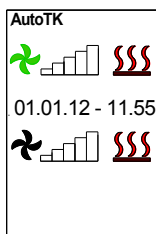

Press the **Mode** key (**PGM Mode** display). Select **AutoTK** using the multifunctional rotary knob (the text colour will change from orange to black). Press the knob to confirm the selection. **AutoTK** will be displayed in the top display line.

Select a fan setting by turning the multifunctional rotary knob to the right or left. Press the knob to confirm the selection (default setting: fan setting = **0** and heating **OFF**).

Again press the **MODE** key to activate the selected operational mode.

When the doors are opened, the fan setting set in advance will be activated through an optional door contact switch (external signal emitter).

The system must have been provided with a turning-off delay to prevent that the air curtain system is turned on or off every time the door is opened or closed. This **Nachlauf (turning-off delay)** can be set in the **BASIC (basic settings)** menu to 10 - 300 sec. (default setting: **turning-off delay 60 sec.** See point 5.7).

3. AutoTK (automatic operation with door contact control and room thermostat)

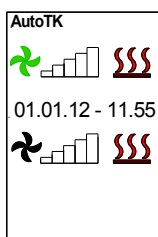

Press the **Mode** key (**PGM Mode** display). Select **AutoTK** using the multifunctional rotary knob (the text colour will change from orange to black). Press the knob to confirm the selection. **AutoTK** will be displayed in the top display line.

Select a fan setting by turning the multifunctional rotary knob to the right or left. Press the knob to confirm the selection (default setting: **fan setting = 0** and heating **OFF**).

Again press the **MODE** key to activate the selected operational mode.

The required room temperature must be set through an optional room thermostat that is connected to the door contact in parallel.

The air curtain system will be turned on using the fan level set in advance after the door with the optional door contact (external signal emitter) and/or the room thermostat has been opened.

The system must have been provided with a turning-off delay to prevent that the air curtain system is turned on or off every time the door is opened or closed. This **Nachlauf (turning-off delay)** can be set in the **BASIC (basic settings)** menu to 10 - 300 sec. (default setting: **turning-off delay 60 sec.**, see point 5.7).

4. AutoTA (automatic operation with cooling protection and door contact control)

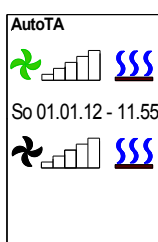

Press the **Mode** key (**PGM Mode** display). Select **AutoTA** using the multifunctional rotary knob (the text colour will change from orange to black). Press the knob to confirm the selection. **AutoTA** will be displayed in the top display line.

Select a fan setting by turning the multifunctional rotary knob to the right or left. Press the knob to confirm the selection (default setting: **fan setting = 0** and heating **OFF**).

Again press the **MODE** key to activate the selected operational mode.

The temperature of the cooling protection must be set on an optional room thermostat. If the temperature drops below the set value, the optional solenoid valve will be opened automatically and the fans will be turned on at setting 1 (the **AKS** display will flash red).

If the doors are opened, the system will switch to the fan level set in advance through an optional door contact switch (external signal emitter).

The system must have been provided with a turning-off delay to prevent that the air curtain system is turned on or off every time the door is opened or closed. This **Nachlauf (turning-off delay)** can be set in the **BASIC (basic settings)** menu to 10 - 300 sec. (default setting: **turning-off delay 60 sec.**, see point 5.7).



5. Settings in the Basic menu (basic settings)

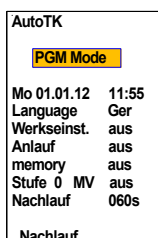

Press the **Mode** key (**PGM Mode** display). Select **Basic** by using the multifunctional rotary knob (the text colour will change from orange to black). Press the knob to confirm the selection.

A menu will be displayed with the different setting options.

5.1 Tag / Datum / Zeit (day/date/time)

Press the multifunctional rotary knob and turn it to select and change the related data (24-hour notation).

5.2 Language

Press the multifunctional rotary knob and turn it to select and change the related data.

If required, you can switch from German to English (other languages will become available soon).

5.3 Werkseinstellung (default setting)

Press the multifunctional rotary knob and turn it to select and change the related data.

The original data is restored.

5.4 Anlauf (turn-on time)

Press the multifunctional rotary knob and turn it to select and change the related data.

After the air curtain has been switched on, the speed will switch to setting 1 during 3 seconds and, next, to setting 5 for another 3 seconds automatically. Next, the system will operate based on the set fan setting (default setting: **turn-on time off**).

5.5 Memory

Press the multifunctional rotary knob and turn it to select and change the related data. The memory function ensures that all set values are kept saved in case of power outage. (Default setting: **memory on**).

5.6 Stufe 0 MV (setting 0 MV)

Press the multifunctional rotary knob and turn it to select and change the related data.

Stufe 0 MV aus = optional solenoid valve is closed when the fans are not turning.

Stufe 0 MV var = optional solenoid valve will be variable for the heating depending on the setting operated when the fans are not turning.
(Default setting: **setting 0 MV off**).

5.7 Nachlauf (turning-off delay)

Press the multifunctional rotary knob and turn it to select and change the related data.

The turning-off delay at door contact operation can be set between 10 and 300 sec. (Default setting: **turning-off delay 60 sec.**)

6. Error messages are displayed in orange

Keine Freigabe (no release) will be displayed when the building management system (DDC) does not release the air curtain system for use. The system cannot be put into service.

Cancel error message

The message will be cancelled automatically when the building management system has released the system.

7. Faults are shown in red

Frostalarm (frost protection) will be displayed when the temperature of the supplied air is lower than approximately 7° C on the optional frost protection thermostat. The fans will be turned off and the optional solenoid valve will be opened.

This function always has priority!

Cancel error message

When the freezing risk is no longer present, the error message will be cancelled automatically and the normal operation of the air curtain system will be resumed.

Motortemperatur (motor temperature) will be displayed when the optional temperature control is activated (fan motors). The relevant air curtain will be put out of service.

The system must be checked (contact a specialised installation company).

Cancel error message

Press the **Mode** key (**PGM Mode** display). Turn the multifunctional rotary knob to select the **Quittierung (cancel)** option and press the rotary knob to confirm the selection.

8. Details



At most 10 air curtain systems can be managed using one control panel with the GTM II control. Each printed circuit board is equipped with a coding switch for this purpose. The coding reads as follows:

0= MASTER, 1 - 9 = SLAVE.

NOTE: never use the same coding for two systems.

The error message will be generated as a collective fault in the MASTER system when a fault occurs.

Only the faulty system will be put out of service in relation to **Motortemperatur (motor temperature)**.

When the system is turned on, first the slave systems must be supplied with power.

Potential-free messages

Function and fault messages are available on the printed circuit board in the form of change-over switches.

If input does not follow in the programming mode (**PRG Mode**) for more than 60 seconds, the mode will be terminated automatically.

9. Troubleshooting

Error	Display	Possible causes	Solution
System is not working	Display off	No grid power supply Not turned on	Turn on the grid power supply Turn on the system
	Keine freigabe (no release)	Fault in DDC release	See point 6
	Frostalarm (frost protection)	Air supply temperature too low	Increase the air supply temperature
	Motortemperatur (motor temperature)	Fan faulty	Replace the fan (see point 7)
Insufficient airflow speed		Air supply filter dirty	Clean the filter
	com error (communication error)	Error in data transfer	Reset

The air curtain system must be reset when a fault occurs. Disconnect the power supply from the whole system. Wait 10 seconds and again turn on the system (also see point 8).

10. Schedule

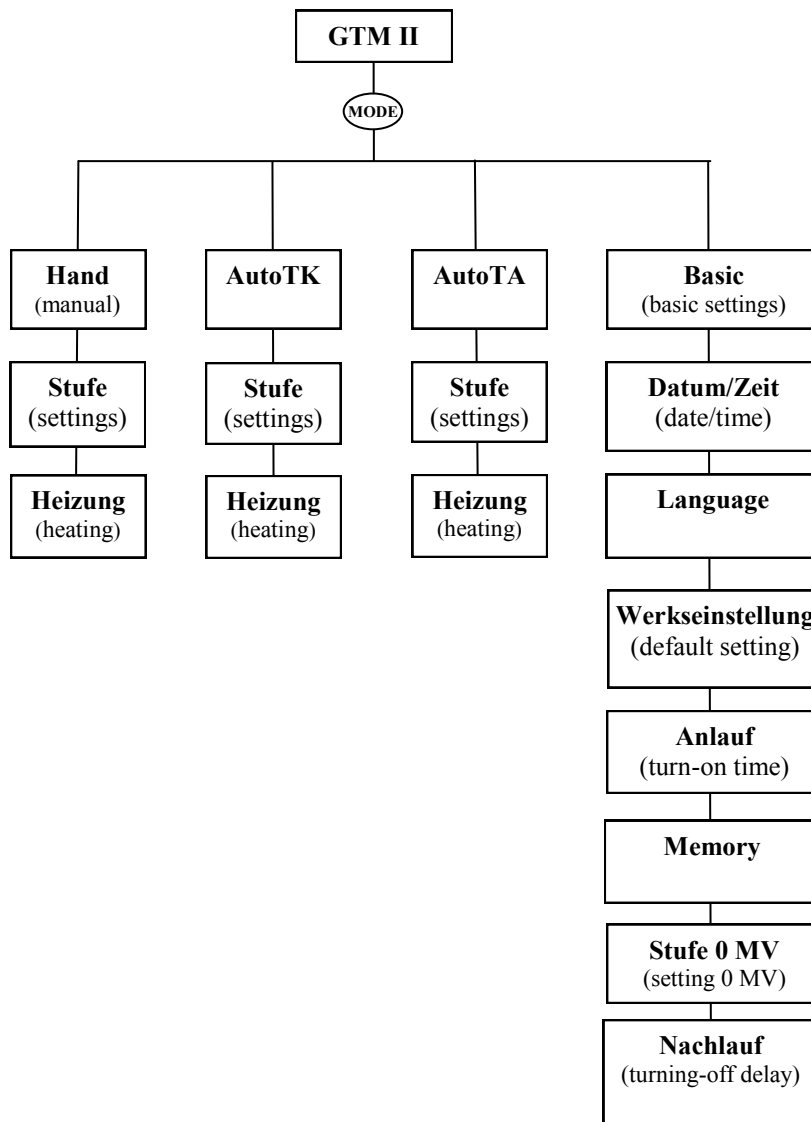

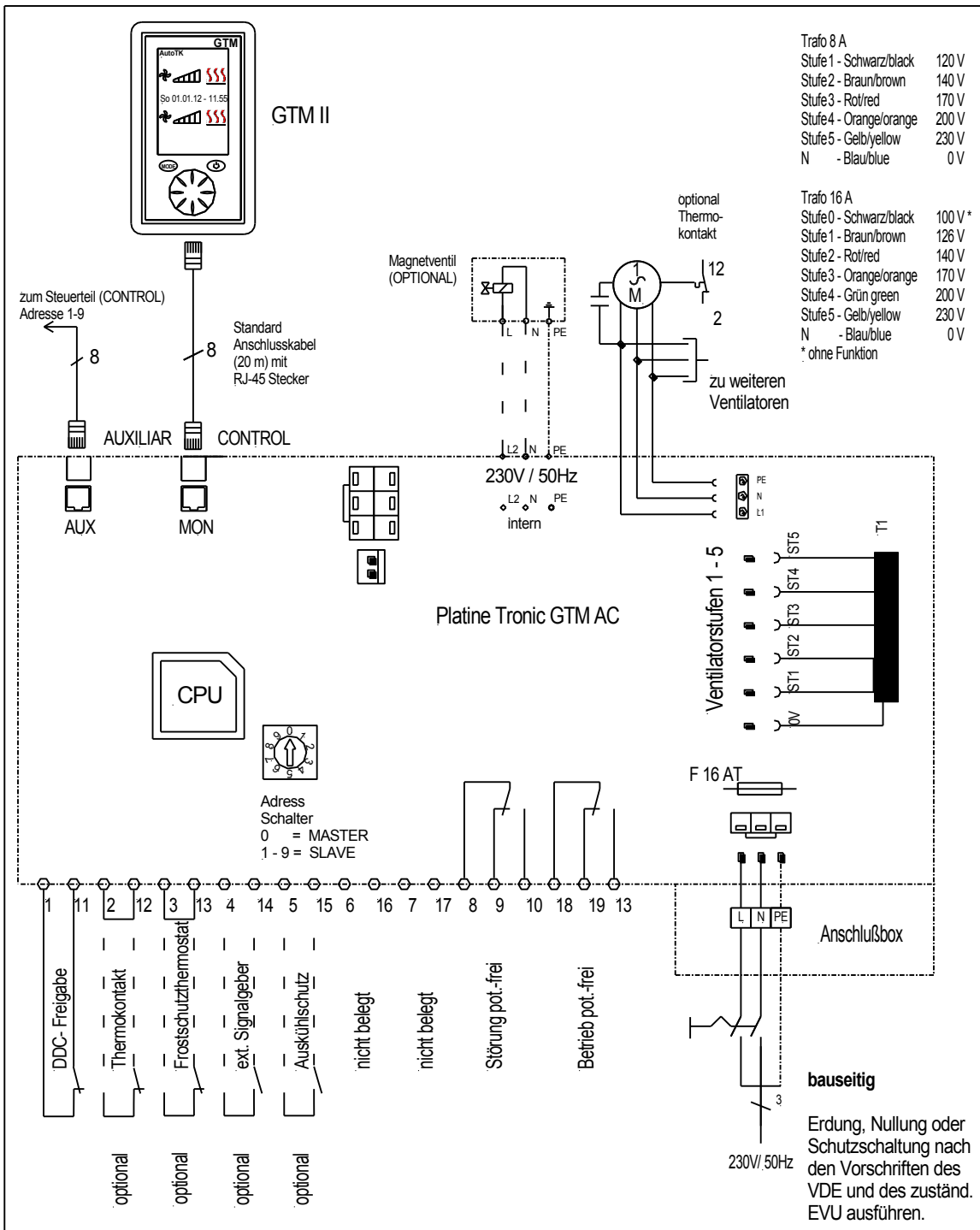

Technische Änderungen vorbehalten

gezeichnet/signet	Name la	Datum 01.01.2012				
			Werkstoff			Maßstab
			Pos.	von	Gruppe	Teile
Kundenzeichnung Nr.:			Erstelldatum			
Benennung Name			GTM II AC 120101			
Kunde						Blatt 1 von 1