

DIN

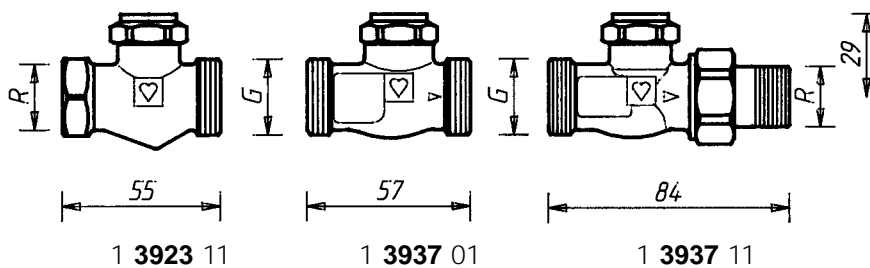

Special Models

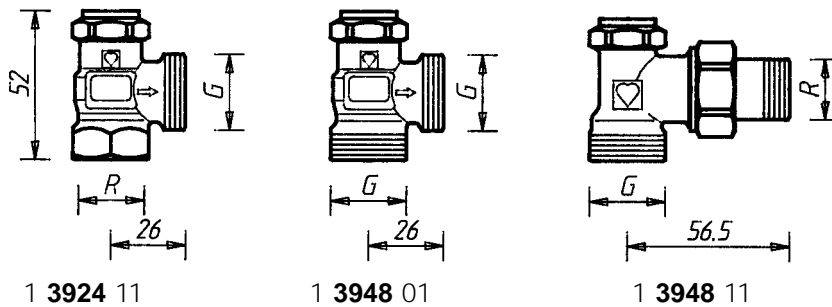

R = R 1/2"
G = G 3/4

Article-number	Model	Connection D, d2	l2	l4	H	l5	Order number
3923	Straight model DARE	3/8"	75	-	30	-	1 3923 00
		1/2"	81	-	30	-	1 3923 01
		3/4"	92	-	30	-	1 3923 02
3924	Angle model EARE	3/8"	-	51	29	23	1 3924 00
		1/2"	-	57	29	25	1 3924 01
		3/4"	-	67	29	28	1 3924 02

Dimensions in mm
According to
DIN 3824 – Series 1
Order numbers

All models are nickel-plated and are universal models with special socket threaded pipe and compression union.

Finish

HERZ-RL-5 valves, special model, dimension 1/2"

- 1 **3923** 11 Straight model, universal socket x male thread G 3/4, with cone seal
- 1 **3937** 01 Straight model, 2 x male threads G 3/4, with cone seal
- 1 **3937** 11 Straight model, radiator connection with cone seal, pipe connection male thread G 3/4
- 1 **3924** 11 Angle model, universal socket x male thread G 3/4, with cone seal
- 1 **3948** 01 Angle model, 2 x male thread G 3/4, with cone seal
- 1 **3948** 11 Angle model, radiator connection with cone seal, pipe connection male thread G 3/4

HERZ-RL-5
Special Models

We reserve the right to make
modifications necessitated by
technological progress.

The universal models are equipped with special sockets offering the option of connecting either a threaded pipe or a calibrated soft-steel or copper pipe, the latter two by means of compression union. The compression union must be ordered separately.

When using R = 1/2" valves for external pipe diameters of 10, 12, 14, 16 and 18 mm use adapter Art. No. 6272 between valve and compression union.

Pipe ø D mm	12	10	12	14	15	16	18	18
Valve R =	3/8"	1/2"						3/4"
Adapter Order No.		1 6272 01	1 6272 01	1 6272 01		1 6272 01	1 6272 11	
Compr. Union Order No.	1 6292 00	1 6284 00	1 6284 01	1 6284 03	1 6292 01	1 6284 05	1 6289 01	1 6292 02

We recommend the use of support sleeves for the installation of soft-steel or copper pipes with screw joint. For perfect installation, it is imperative to lubricate the thread of the locking nut (male thread and female thread) as well as the olive itself with silicon oil. We refer to our instructions for installation.

Universal Model Pipe Connection

Closing is performed by means of a valve spindle which can be turned to open or close by means of a multi-purpose key **6625**. The valve cone opening can be limited by means of the inner spindle resulting in several finely stepped valve positions. These valve positions which are to be set according to the standard diagram cannot be lost again, i.e. they are not affected by opening or closing the valve cone.

Special Design Features

1. Unscrew plug.
 2. Close the valve by means of the multi-purpose key (turn clockwise, torque max. 6 Nm).
 3. Use the HERZ key **6639 01** or a screw driver to turn the presetting screw clockwise approximately 3 mm up to the stop. From this position, set at the desired presetting step according to standard diagram by turning counterclockwise. One turn corresponds to one presetting step.
 4. Open valve up to the stop by means of the multi-purpose key (turn clockwise).
 5. Tighten plug and seal (tightening torque 5–10 Nm).
- Attention:** The HERT-RL-5 valve is supplied by the manufacturer with the valve and presetting completely open. The presetting spindle must **not** be turned counterclockwise any further from this position. The screw head must not project from the main spindle.

Pre Setting

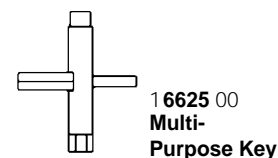

After removing the plug, close HERZ-RL-5 valve (torque 5–8 Nm) by means of multi-purpose key and close the intake valve (at the thermostatic head, 0-position). Then, the radiator can be emptied while the heating system remains under pressure.

1. Screw hose connection adapter **1 0256 01** onto the HERZ-RL-5 valve.
2. Connect hose R = 1/2". The hose end should be below the radiator level. The neck of the hose connection adapter can be turned after slackening the nut of the square end side. Tighten the nut again after turning (5–10 Nm).
3. Place multi-purpose key on the square. Snap spindle into the upper part by exerting pressure in the direction towards the HERZ-RL-5 valve. Turn counterclockwise up to the stop to open the return valve towards outside in order to start the draining process. Keep the radiator bleeding valve open during draining.
4. After draining close upper part by turning (8–10 Nm) and remove hose connection adapter. Screw on plug with seal (tighten torque 5–10 Nm).
5. Then, it is possible to remove the radiator.

Draining



Hose Connection
Adapter 1 0256 01

Filling takes place but in reverse order. Make sure that the maximum permissible operating pressure of the heating system is not exceeded. The radiator can be filled via the heating system by opening the valve spindle.

Filling

The valve and pre-setting spindle are sealed with O-rings. These guarantee ease of valve operation and keep the valve permanently maintenance-free up to the specified operating temperature.

Spindle Sealing

The seat seal is metallic and therefore non-wearing.

Seat Seal

The valve is protected against manipulation by unauthorized persons by means of a metallic cap with seal screwed onto it.

Safety Device

- 1 0256 01 Hose connection adapter
- 1 6206 01 Hose connection
- 1 6625 00 Multi-purpose key
- 1 6639 01 Pre-setting key (screw-driver with indicator sleeve)
- 1 6680 00 Assembly key

Accessories

- 1 6304 00 Upper part with spindle sealing

Spare Part

Maximum operating temperature 110 °C
 Maximum operating pressure 10 bar

Hot water quality according to Austrian standard ÖNORM H 5195 and/or VDI guideline 2035.

When using HERZ compression unions for copper and steel pipes, observe the permissible temperatures and pressures as specified in EN 1254-2:1998 Table 5. A maximum operating temperature of 80 °C and maximum operating pressure of 4 bar applies for plastic pipe connections, if permitted by the pipe manufacturer.

Operating Data

HERZ Compression Union

Hot Water Heating Systems.

After installation of the return valve it is possible to close the radiator return connection. When the intake valve is closed simultaneously ("0"-position for thermostat valves) it is possible to remove the radiator while the heating system remains under pressure. Servicing and working behind the radiator (repapering, laying tiles) is possible without having to switch off the rest of the system.

The HERZ-RL-5 valve adjusts to allow the exact water quantity to flow through the radiator according to the heat requirements. This is recommended particularly in systems equipped with thermostatic valves because lowering the temperature during nighttime becomes fully effective in terms of reducing power input when the water flow quantity is limited and the hydraulic equilibrium of the system is retained.

The HERZ-RL-5 valve permits filling or draining the radiator or the entire heating system.

Field of Application

Iron pipe connection 6210, with cone seal, pitted.
 It is recommended that the HERZ assembly key 6680 be used.

Radiator connection

To be used instead of radiator connection G 3/4.

- | | | |
|-------------|-----------|---|
| 6210 | 1/2" | Iron pipe connection, lengths 26 or 35 mm |
| 6211 | 1/2" | Reducing connection, 1/2" x 3/8". |
| 6213 | 3/8" | Reducing connection, 3/8" x 1/2". |
| 6218 | 3/8"-3/4" | Long threaded bush, without nut, can be shortened to compensate for differences in structural dimensions. Lengths 3/8" x 40; 1/2" x 39, 42 and 76; 3/4" x 70 mm. |
| 6218 | 1/2" | Threaded bush, without nut, lengths 36, 48 and 76 mm. |
| 6235 | 3/8"-3/4" | Soldering connection 3/8" x 12; 1/2" x 12, 15 and 18 mm; 3/4" x 18 mm. |
| 6249 | 3/8"-3/4" | Iron pipe connection elbow, without nut, with cone seal. |
| 6274 | G 3/4 | Compression union for copper and thin-walled steel pipes, for external pipe diameters 8,10,12,14,15,16 and 18 mm. |
| 6275 | G 3/4 | Compression union with soft seal for copper and thin-walled steel pipes, particularly suitable for hard special steel pipes and pipes with hard galvanised surfaces. For external pipe diameters 12,14 and 15 mm. |
| 6098 | G 3/4 | Compression union for PE-X-, PB and plastic composite pipes. |

For use on the socket side of the valve:

- | | | |
|-------------|------------|---|
| 6219 | 1/2"-3/4" | Reduction socket, brass, for connecting pipe and valve, female thread (pipe) x male thread (valve) 1" x 1/2", 1 1/4" x 1/2"; 1 x 3/4", 1 1/4" x 3/4". |
| 6066 | M 22 x 1,5 | Plastic pipe connection for PE-X-, PB and plastic composite pipes, for use with adapter 1 6272 01 (R 1/2 x M 22 x 1.5). |
| 6098 | G 3/4 | Plastic pipe connection for PE-X, PB and plastic composite pipes, for use with adapter 1 6266 01 (R 1/2 x G 3/4). |

For pipe dimensions of plastic pipe connections refer to the HERZ catalogue.

Further Connecting Options

Please refer to the HERZ Catalogue for order numbers.

HERZ-RL-5 Table for Pre-Setting, kv- and Zeta Values

Valve	3923 - 3/8" DARE DN 10		3923 - 1/2" DARE DN 15		3923 - 3/4" DARE DN 20	
	kv	ξ	kv	ξ	kv	ξ
V						
0.25	0.05	14 817	0.05	40 489	0.05	134 168
0.5	0.12	2 572	0.12	7 029	0.12	23 293
0.75	0.17	1 282	0.17	3 503	0.17	11 606
1	0.23	700	0.23	1 914	0.23	6 341
2	0.44	191	0.44	523	0.44	1 733
3	0.55	123	0.6	281	0.6	932
4	0.72	72	0.8	158	0.8	524
5	0.95	41	1.0	101	1.0	335
6	1.12	30	1.16	75	1.3	199
7	1.19	26	1.26	65	1.34	187
8	1.21	25	1.32	58	1.47	155
9	1.27	23	1.38	53	1.55	140
10	1.4	19	1.5	45	1.65	123
Valve	3924 - 3/8" EARE DN 10		3924 - 1/2" EARE DN 15		3924 - 3/4" EARE DN 20	
V	kv	ξ	kv	ξ	kv	ξ
0.25	0.05	14 817	0.05	40 489	0.05	134 168
0.5	0.12	2 572	0.12	7 029	0.12	23 293
0.75	0.17	1 282	0.17	3 503	0.17	11 606
1	0.23	700	0.23	1 914	0.23	6 341
2	0.44	191	0.44	523	0.44	1 733
3	0.6	103	0.6	281	0.6	932
4	0.8	58	0.8	158	0.8	524
5	1.1	31	1.1	84	1.1	277
6	1.3	22	1.3	60	1.3	199
7	1.45	18	1.45	48	1.45	160
8	1.6	15	1.6	40	1.6	131
9	1.75	12	1.75	33	1.75	110
10	1.9	10	1.9	28	1.9	93

HERZ Standard Diagram

HERZ-RL-5

Article No. 3923 · 3924

Dim. DN 10 R=3/8" · DN 15 R=1/2" · DN 20 R=3/4"

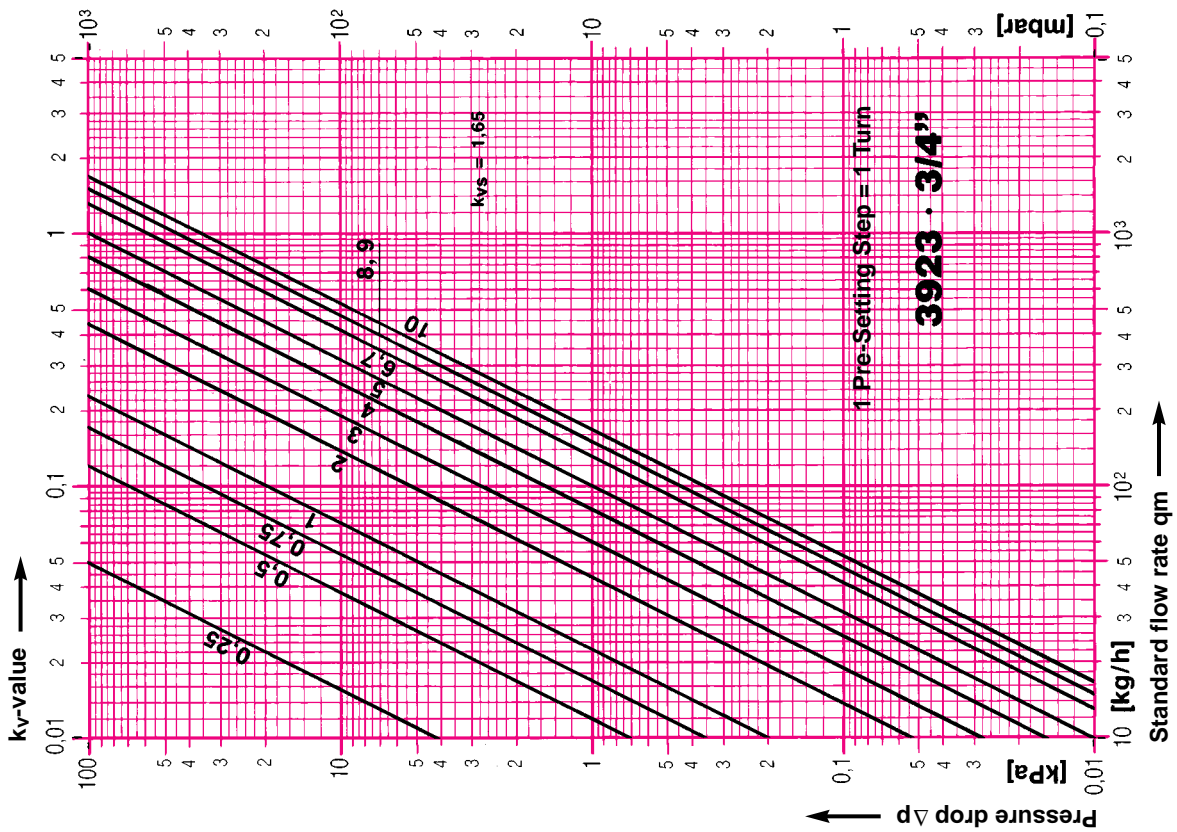
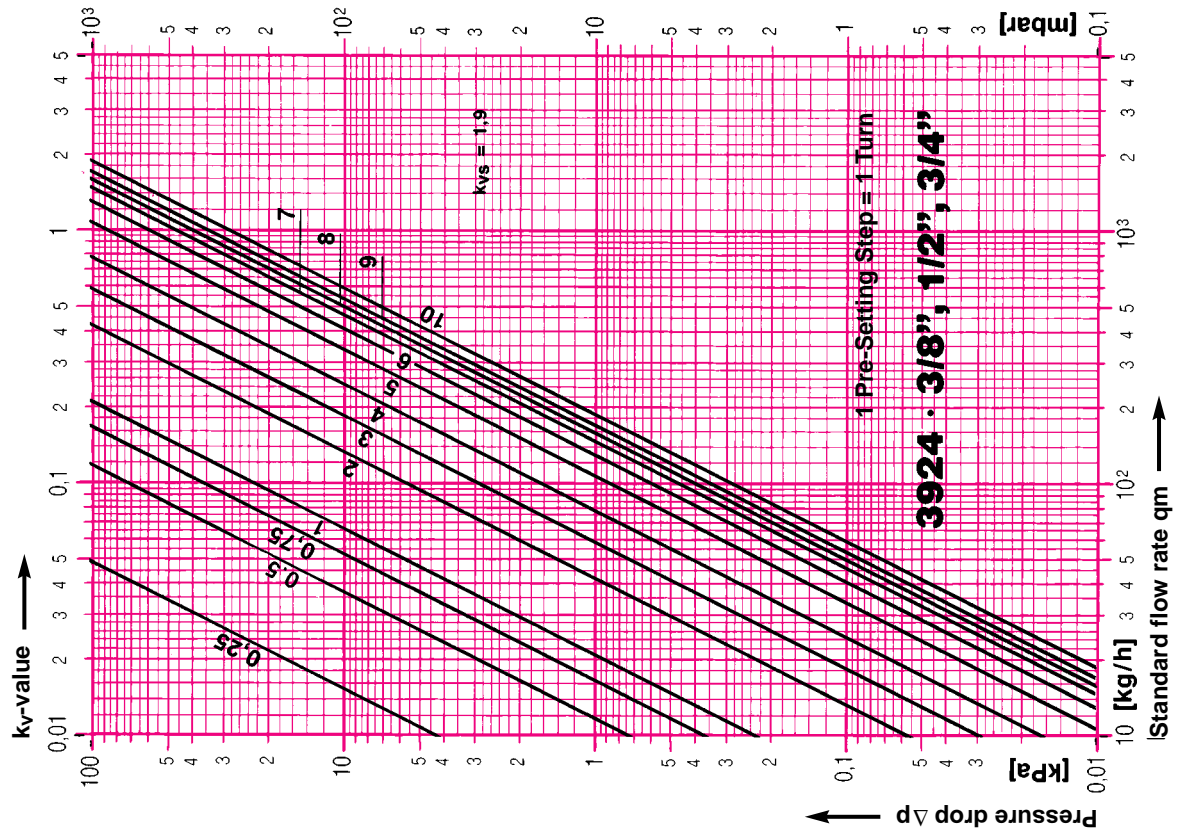

We reserve the right to make modifications.

HERZ Armaturen

Richard-Strauss-Straße 22 · A-1230 Wien



HERZ Standard Diagram

HERZ-RL-5

Article No. 3923

Dim. DN 10 R=3/8" · DN 15 R=1/2"

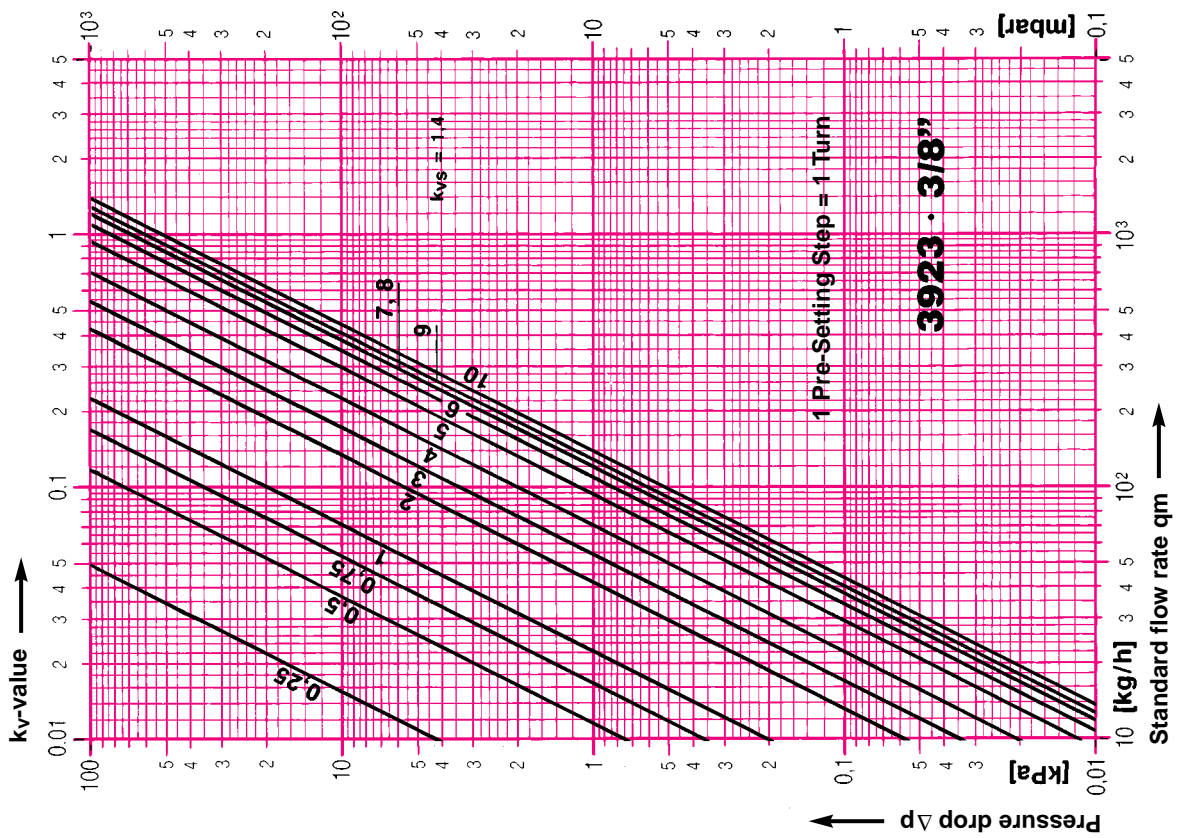
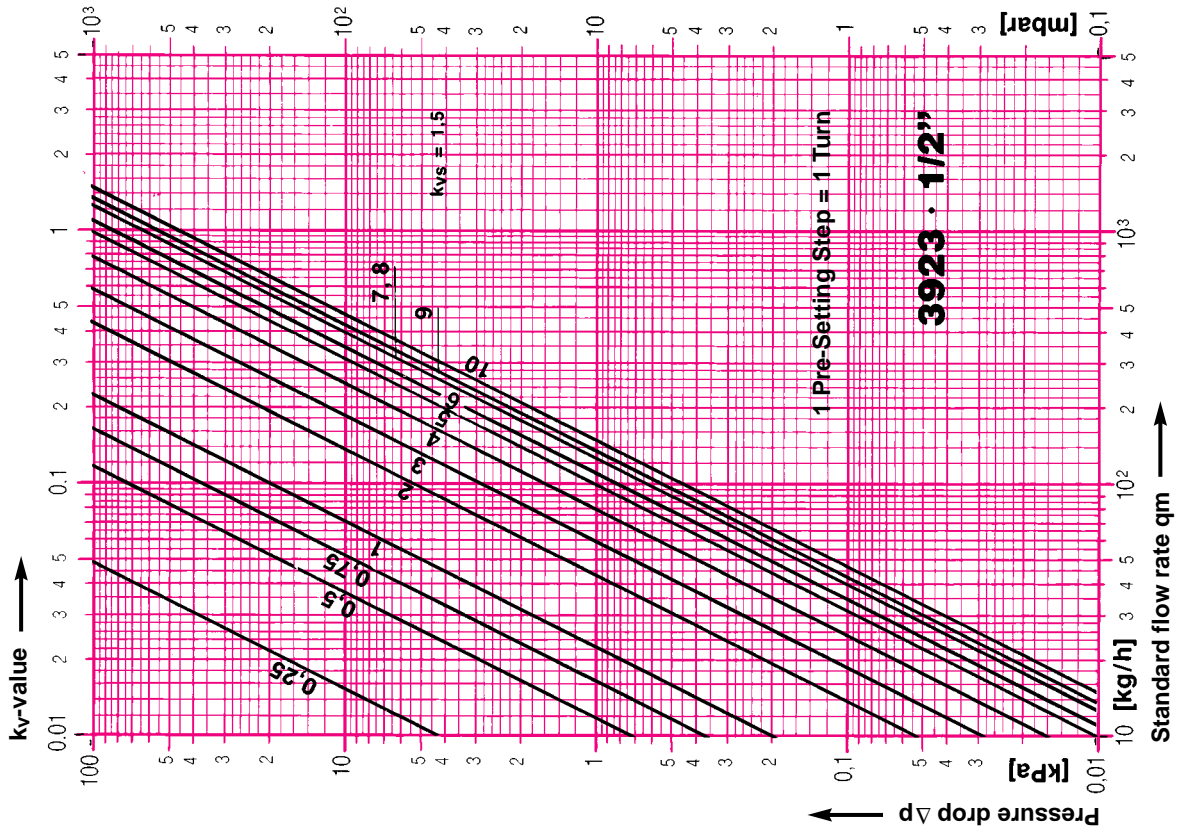

We reserve the right to make modifications.

HERZ Armaturen

Richard-Strauss-Straße 22 · A-1230 Wien

