

versatile

NET ZERO

XS Net Zero
BASE-Line

Aesthetics and
sustainability in a
discrete package



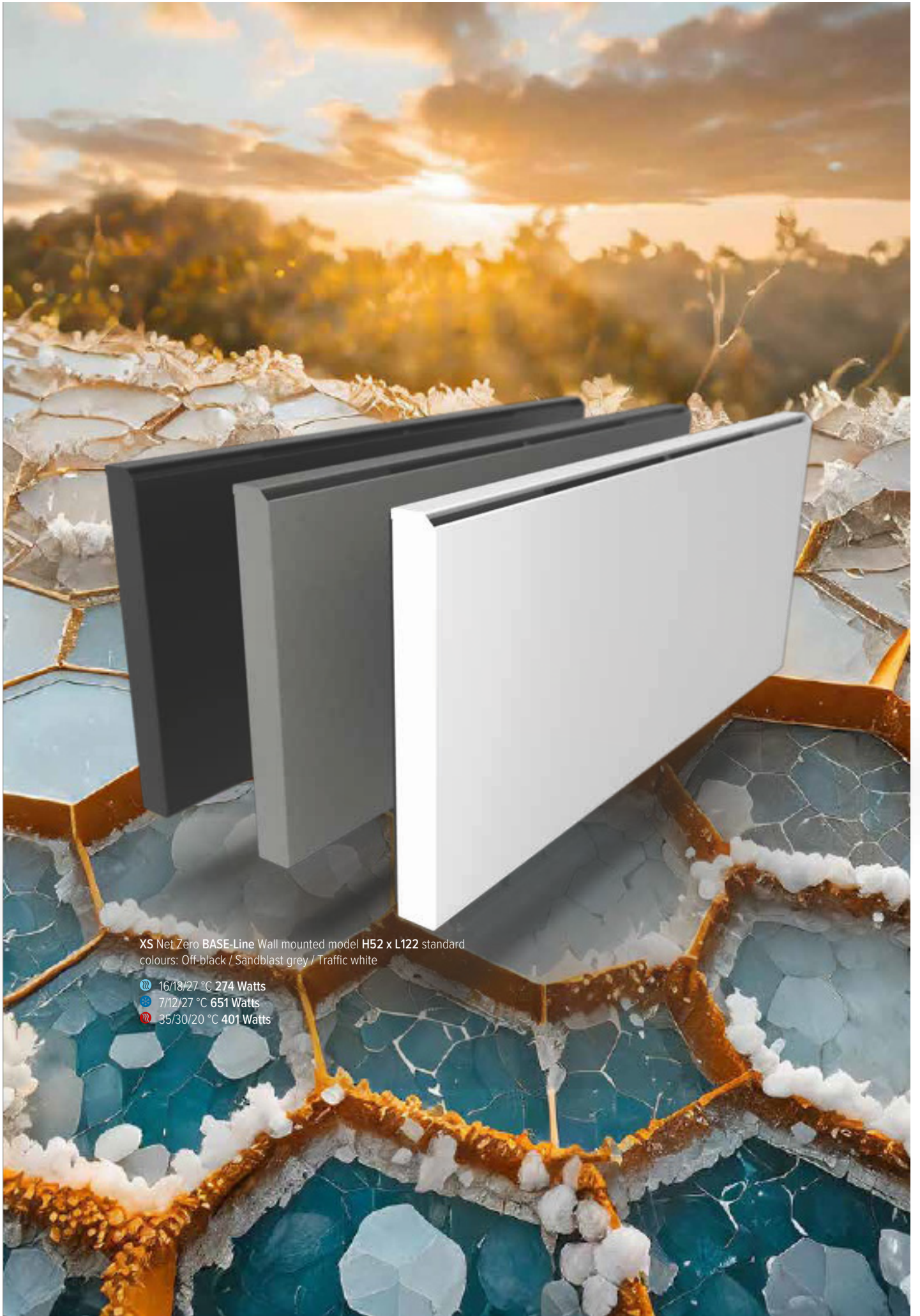

XS Net Zero BASE-Line Wall mounted model H52 x L122 standard
colours: Off-black / Sandblast grey / Traffic white

- 16/18/27 °C 274 Watts
- 7/12/27 °C 651 Watts
- 35/30/20 °C 401 Watts

WALL MOUNTED MODEL



PLUG & PLAY TPT 4

Complete unit with temperature regulation via pre-assembled control panel, valve set and 230 V power supply

- height 52 cm
- length 86, 122, 163 or 199 cm
- 16/18/27°C: from 137 to 566 Watts (10 V)
- 7/12/27°C: from 326 to 1348 Watts (10 V)
- 35/30/20°C: from 201 to 831 Watts (10 V)



PLUG & PLAY JIC 4

Complete unit with temperature regulation via the Jaga App, valve set and 230 V power supply

- height 52 cm
- length 86, 122, 163 or 199 cm
- 16/18/27°C: from 137 to 566 Watts (10 V)
- 7/12/27°C: from 326 to 1348 Watts (10 V)
- 35/30/20°C: from 201 to 831 Watts (10 V)

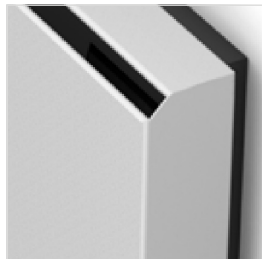

CONFIGURABLE UNIT 12

Water-side and electrical connections tailored to your installation

- height 52 cm
- length 86, 122, 163 or 199 cm
- 16/18/27°C: from 137 to 566 Watts (10 V)
- 7/12/27°C: from 326 to 1348 Watts (10 V)
- 35/30/20°C: from 201 to 831 Watts (10 V)

CEILING MOUNTED MODEL



PLUG & PLAY JIC 5

Complete unit with temperature regulation via the Jaga App, valve set and 230 V power supply

- width 53 cm
- length 86, 122, 163 or 199 cm
- 16/18/27°C: from 137 to 566 Watts (10 V)
- 7/12/27°C: from 326 to 1348 Watts (10 V)
- 35/30/20°C: from 201 to 831 Watts (10 V)

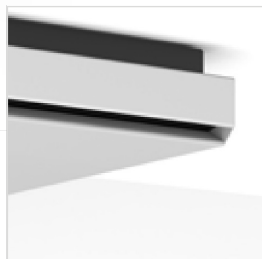

CONFIGURABLE UNIT 20

Water-side and electrical connections tailored to your installation

- width 53 cm
- length 86, 122, 163 or 199 cm
- 16/18/27°C: from 137 to 566 Watts (10 V)
- 7/12/27°C: from 326 to 1348 Watts (10 V)
- 35/30/20°C: from 201 to 831 Watts (10 V)

XS NET ZERO PLUG & PLAY WALL-MOUNTED MODEL

We strive to market our dynamic radiators as ready for installation as possible. Where earlier we only had to connect the water supply, what is now required is also a power supply, an electronic control system and a thermostat connection. For your installation comfort, we developed a Plug & Play product line with the same high-quality value and with all connection options pre-assembled. Order care-free for an effortless installation!

DIFFERENT TEMPERATURE SETTINGS

CONTROL PANEL (TPT)



The room temperature is set on the control panel.

- Heating from 16 to 26°C
- Cooling from 16 to 26°C

JAGA APP (JIC)

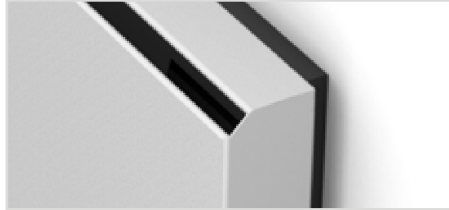

- With the Jaga Home App, end users have full control over their indoor climate.
- With the Jaga Pro App, installation technicians are able to streamline their activities remotely, enhance productivity and offer support to their customers.

ELECTRICAL CONNECTION

Clamp connector for electrical connection 24 VDC on the right, via 230 VAC power supply to be connected

HYDRONIC CONNECTION (left)

preassembled valves, connection Eurocone 3/4"

Eurocone connection set with thermoelectric motor

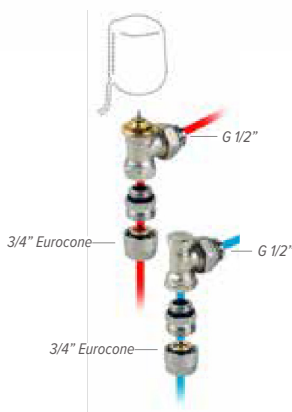

set 289 KVS 0.8 - default setting in 6 steps

XS NET ZERO **PLUG & PLAY** CEILING MOUNTED MODEL

The very first Plug & Play ceiling model.

Control your comfort and optimise your installation with the Jaga App.

DIFFERENT TEMPERATURE SETTINGS

APP (JIC)



- With the Home App, end users have full control over their indoor climate.
- With the Pro App, installation technicians are able to streamline their activities remotely, enhance productivity and offer support to their customers.

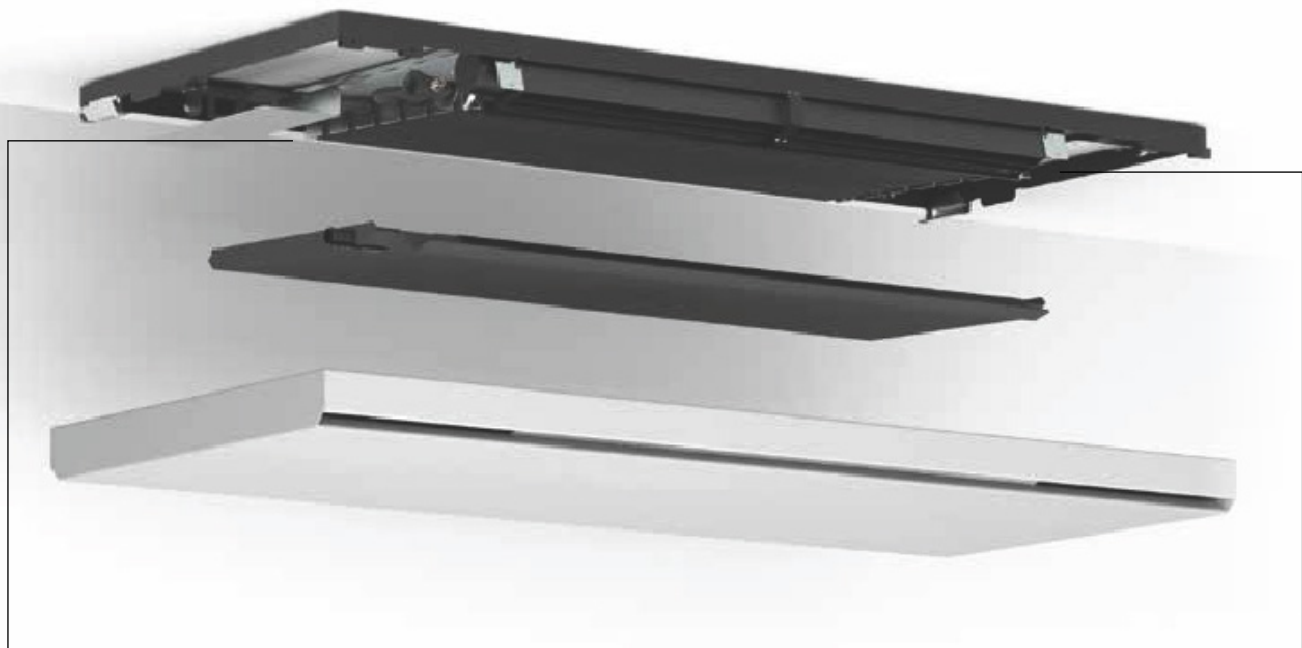

HYDRONIC CONNECTION (left)

preassembled valves, connection Eurocone 3/4"

Eurocone connection set with thermoelectric motor

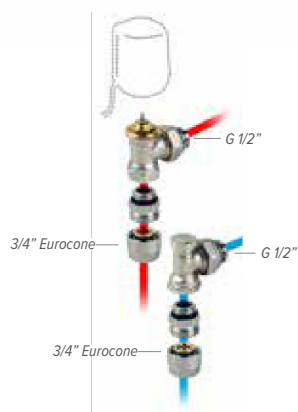

ELECTRICAL CONNECTION

Clamp connector for electrical connection 24 VDC on the right, via 230 VAC power supply to be connected

Set **289** **KVS 0.8 - default setting in 6 steps**

XS NET ZERO BASE-LINE PLUG & PLAY

CONTROL SYSTEMS

TEMPERATURE REGULATION VIA CONTROL PANEL (TPT)



The room temperature is set on the control panel.

- Heating from 16 to 26°C
- Cooling from 16 to 26°C

APP (JIC)



Home App (for the end-user)

The Home App is a user-friendly platform specifically developed for end users, offering them effortless control over their heating and cooling systems with a few touches on their smartphones or tablets. Whether it's to adjust the temperature, to create the perfect atmosphere or for setting the air flow for optimal comfort, the Home App hands full control over to the user.

These are the most important features of the Home App:

- **Remote control:** Control your heating or cooling system from any remote location, for unprecedented flexibility and user convenience.
- **Adjustable settings:** Adjust the settings to your liking, creating a home environment just the way you like it.
- **Insight into energy efficiency:** Gain valuable insights into your energy consumption and optimise your system for maximum efficiency, resulting in saving energy as well as money.
- **Intuitive interface:** User-friendly interface that simplifies control.



WiFi



App

Home App



Pro App



Choose the desired system



Program your weekly program

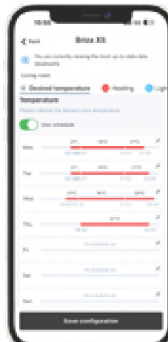

Select the desired temperature

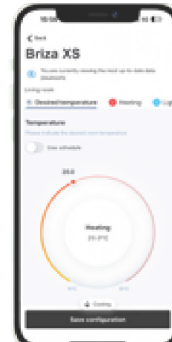

Pro app (for the installer)

For installation technicians, the Pro App is a powerful tool to manage projects, support customers remotely and to have access to essential resources, such as manuals for hardware and installation videos.

These are the most important features of the Pro App:

- **Project Management:** Monitor the progress of active projects, from first installation to maintenance and support, to allow everything to run smoothly from beginning to end.
- **Remote Assistance:** Diagnose and solve remotely, supporting customers quickly and efficiently without the need for an installation technician to personally stop by.
- **Access to Documentation:** Direct access to manuals and installation videos for products, providing all information for installation technicians within reach.
- **Improved Customer Service:** Deliver outstanding service to your customers by quickly and efficiently solving issues, meanwhile increasing customer satisfaction and reliability.

Create/Manage Project(s)

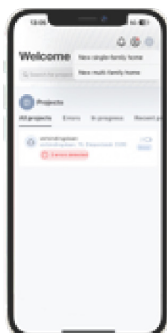

View unit details, including error reports and control panel



Consult Product Information

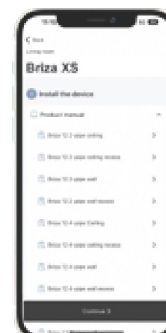

UNDER DEVELOPMENT

XS NET ZERO BASE-LINE PLUG & PLAY

RANGE

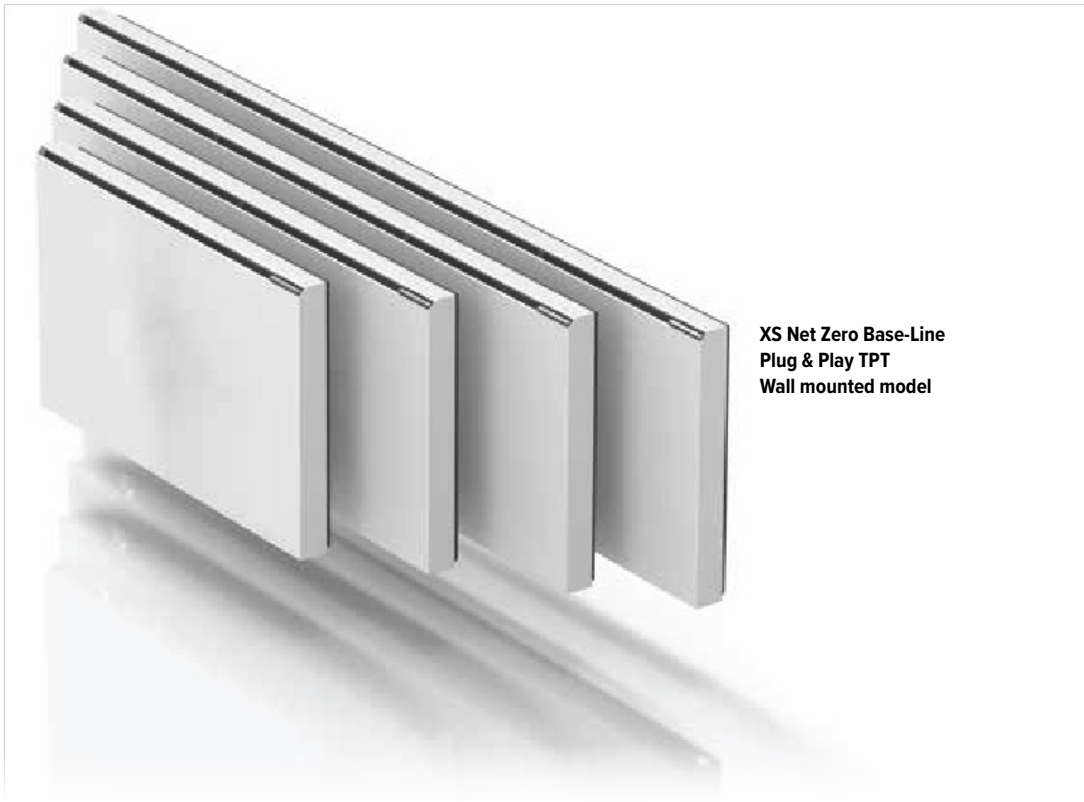

**XS Net Zero Base-Line
Plug & Play TPT
Wall mounted model**

**XS Net Zero Base-Line Plug
& Play JIC
Wall mounted model**



**XS Net Zero Base-Line Plug
& Play JIC
Ceiling mounted model**



XS NET ZERO BASE-LINE PLUG & PLAY

DIMENSIONS (in mm)

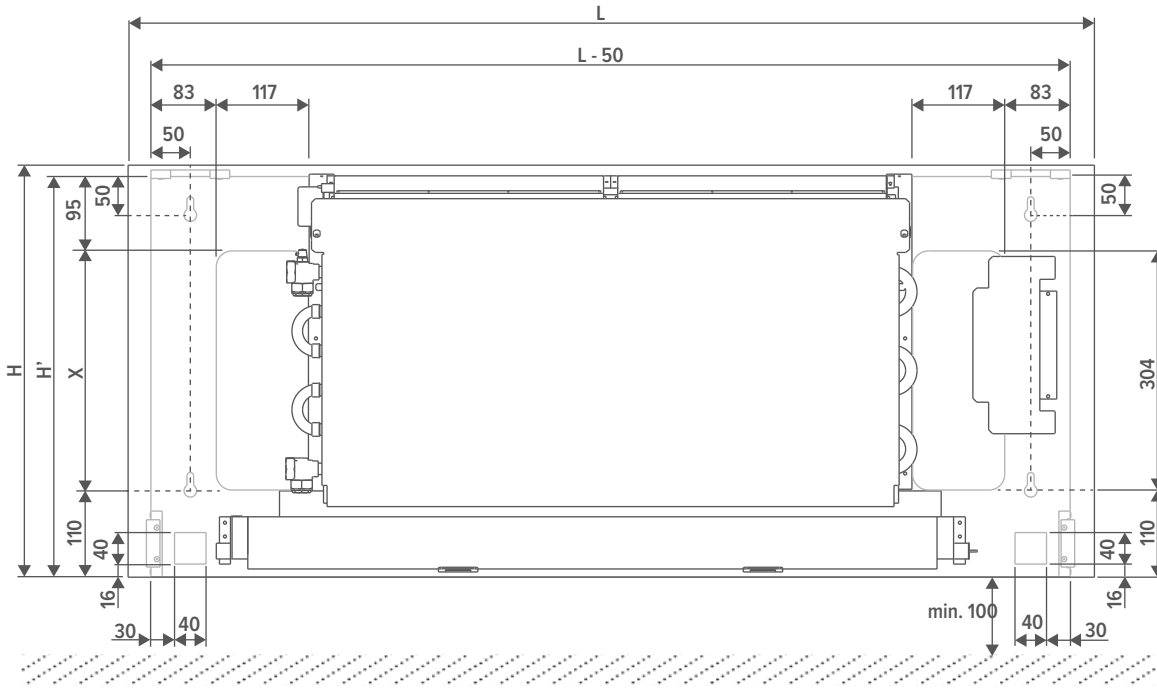

WALL-MOUNTED MODEL (in mm)

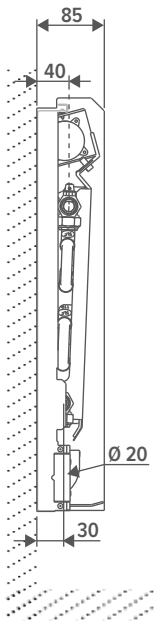

CEILING MOUNTED MODEL (in mm)

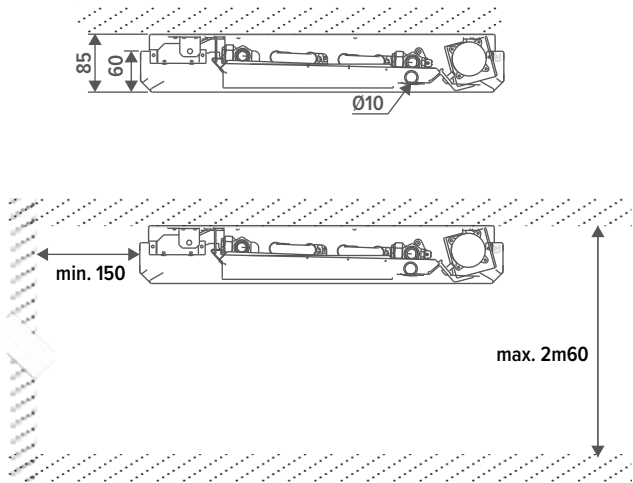

XS NET ZERO BASE-LINE PLUG & PLAY

STANDARD DELIVERY

- coated housing in sendzimir galvanised steel plate
- coated back panel made from Sendzimir galvanised sheet steel
- air outlet vent in the same colour as the casing, supplied with jet black coated honeycomb grille
- robust interior made from electro-galvanised steel, premounted to the back panel
- condensation tray with drain (supplied with insulation)
- Low-H₂O heat exchanger
- thermal Activator(s) (tangential mini activator)
- integrated 230V power supply
- pre-assembled connection set

VERSION TPT

- Control panel

VERSION JIC

- Jaga Home App for end user / Jaga Pro App for installation technician

COLOURS

Casing

Standard colours

- traffic white RAL 9016 (133), soft touch lightly structured satin lacquer
- sandblast grey (001), fine texture metallic lak
- off-black (145), soft touch lightly-textured satin lacquer

Other colours

see colour chart

Back panel

Standard colour

- jet black (104) soft touch lightly structured satin powder coating
- traffic white RAL 9016 (133), soft touch lightly structured satin lacquer (ceiling model only)

CONNECTION

Standard

- hydronic connections on the left
- clamp connector for electric connection 24 VDC, to connect via an external power supply, on the right hand side.

Optional

Hydronic right, electric left. Connection code **R** instead of **L**. No surcharge.

ORDER CODE PLUG & PLAY WALL-MOUNTED MODEL

BNZW 052 086 XS XXX L BL DDD

Control: TPT: D01
JIC: J01

Connection: Standard: L
Optional: R

Casing colour

Length

ORDER CODE PLUG & PLAY CEILING MOUNTED MODEL

BNZC 053 086 XS XXX X L BL J01

Connection: Standard: L
Optional: R

Back panel colour:
Jet black (104) : B
Traffic white (133): W

Casing colour

Length



Order sleeve couplings 3/4" Eurocone separate



Condensing cooling with a ceiling-mounted model?
Add a condensate pump to your order! (ex. BNZC 053 086 XS 133 B L BL J01 C)

HYDRONIC CONNECTION

WALL-MOUNTED MODEL (in mm)

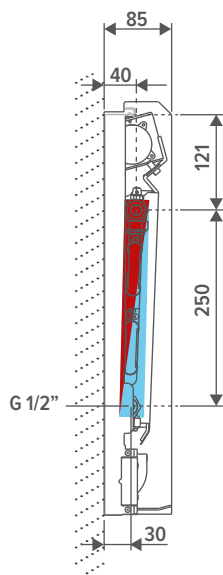

CEILING MOUNTED MODEL (in mm)

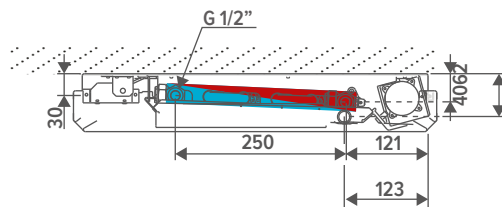

ELECTRICAL CONNECTION

- Upon request for cold or heat, a BMS/home automation system or a thermostat will open the thermoelectric valve.
- Upon request for cold or heat, a thermostat / control will open the thermoelectric valve.

XS NET ZERO BASE-LINE PLUG & PLAY WALL-MOUNTED MODEL

				CONTROL VOLTAGE	COOLING <i>(non-condensing) room temperature 27°C</i>			HEATING <i>room temperature 20°C</i>				SOUND PRESSURE LEVEL	AIR FLOW	ENERGY CONSUMPTION	ORDER CODE
HEIGHT	LENGTH	TYPE	U		16/18	7/12	7/12	35/30	45/40	50/45	55/45				
H	L	T	V	Watts	Watts	Watts	Watts	Watts	Watts	Watts					
cm	cm														
BNZW 052 086 XS			2	18	44	31	45	82	100	109	<20	25	0.5	BNZW 052 086 XS XXX L BL DDD	
			4	58	142	102	84	152	186	202	<20	34	0.8		
			6	91	221	160	122	223	272	295	22.5	47	1.3		
			8	117	282	207	161	293	359	389	29.0	61	2.1		
			10	137	326	242	201	365	446	484	35.5	77	3.0		
122 XS			2	36	89	63	90	164	200	217	<20	26	0.6	BNZW 052 122 XS XXX L BL DDD	
			4	115	285	204	167	304	372	403	<20	56	1.3		
			6	182	443	321	245	445	545	590	28.0	86	2.7		
			8	235	565	414	323	587	718	778	32.5	116	4.6		
			10	274	651	483	401	729	893	967	40.0	145	7.1		
163 XS			2	56	139	99	141	257	314	341	<20	39	1.1	BNZW 052 163 XS XXX L BL DDD	
			4	181	447	320	263	477	584	633	<20	65	2.1		
			6	285	695	504	384	699	855	927	27.5	111	4.0		
			8	368	886	650	507	921	1127	1222	34.5	148	6.6		
			10	430	1022	758	630	1145	1401	1518	42.5	188	10.1		
199 XS			2	74	184	130	186	339	415	449	<20	43	1.2	BNZW 052 199 XS XXX L BL DDD	
			4	239	589	422	346	629	770	835	20.5	71	2.5		
			6	376	917	664	507	921	1127	1222	28.0	131	5.4		
			8	485	1168	857	668	1215	1486	1611	36.5	182	9.1		
			10	566	1348	1000	831	1509	1847	2002	42.0	206	14.1		

Output measured in accordance with EN 16430

*Noise measurement according to ISO 3741:2010, at a 2-m distance from the unit and with an assumed room attenuation of 8 dB(A)/room volume 100 m³ / reverberation time 0.5 sec.

Casing colour |
 Connection: Standard: L
 Optional: R |
 Control: TPT: D01
 JIC: J01 |

XS NET ZERO BASE-LINE PLUG & PLAY CEILING MOUNTED MODEL

WIDTH B cm	LENGTH L cm	TYPE T	CONTROL VOLTAGE U V	COOLING (non-condensing) room temperature 27°C			HEATING room temperature 20°C				SOUND PRESSURE LEVEL dB(A)	AIR FLOW m³/h	ENERGY CONSUMPTION Watts	ORDER CODE
				16/18 Watts	7/12 Watts	7/12 Watts	35/30 Watts	45/40 Watts	50/45 Watts	55/45 Watts				
BNZC 053 086 XS			2	18	44	31	45	82	100	109	<20	25	0.5	BNZC 053 086 XS XXX X L BL J01
			4	58	142	102	84	152	186	202	<20	34	0.8	
			6	91	221	160	122	223	272	295	22.5	47	1.3	
			8	117	282	207	161	293	359	389	29.0	61	2.1	
			10	137	326	242	201	365	446	484	35.5	77	3.0	
122 XS			2	36	89	63	90	164	200	217	<20	26	0.6	BNZC 053 122 XS XXX X L BL J01
			4	115	285	204	167	304	372	403	<20	56	1.3	
			6	182	443	321	245	445	545	590	28.0	86	2.7	
			8	235	565	414	323	587	718	778	32.5	116	4.6	
			10	274	651	483	401	729	893	967	40.0	145	7.1	
163 XS			2	56	139	99	141	257	314	341	<20	39	1.1	BNZC 053 163 XS XXX X L BL J01
			4	181	447	320	263	477	584	633	<20	65	2.1	
			6	285	695	504	384	699	855	927	27.5	111	4.0	
			8	368	886	650	507	921	1127	1222	34.5	148	6.6	
			10	430	1022	758	630	1145	1401	1518	42.5	188	10.1	
199 XS			2	74	184	130	186	339	415	449	<20	43	1.2	BNZC 053 199 XS XXX X L BL J01
			4	239	589	422	346	629	770	835	20.5	71	2.5	
			6	376	917	664	507	921	1127	1222	28.0	131	5.4	
			8	485	1168	857	668	1215	1486	1611	36.5	182	9.1	
			10	566	1348	1000	831	1509	1847	2002	42.0	206	14.1	

Output measured in accordance with EN 16430

*Noise measurement according to ISO 3741:2010, at a 2-m distance from the unit and with an assumed room attenuation of 8 dB(A)/room volume 100 m³ / reverberation time 0.5 sec.

Casing colour

Back panel colour:

Jet black (104) : B

Traffic white (133): W

Connection: Standard: L

Optional: R



XS NET ZERO **BASE-LINE** WALL-MOUNTED MODEL

THERMAL ACTIVATOR(S) (tangential mini activator)

Tangential activators with aluminium fins are provided with ball bearings and resin-coated EPDM vibration damping built-in EC motor for a much lower energy consumption and a longer service life

ROBUST INTERIOR

made from electro-galvanised steel, premounted to the back panel

LOW-H₂O HEAT EXCHANGER

the Low-H₂O heat exchanger is the hyper-reactive, aluminium and copper motor of the ecological products



HYDRONIC CONNECTIONS on the left

CONDENSATE TRAY with outlet spigot ø 2 cm

COATED HOUSING in sendzimir galvanised steel plate



Traffic white 133



Sandblast grey 001

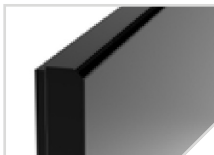

Off-black 145

CONFIGURABLE UNIT



ELECTRICAL CONNECTION

clamp connector for electric connection 24 VDC, to connect via an external power supply, on the right hand side.

BACK PANEL (jet black 104)

For simple installation. The panel is supplied with recesses for water-side and electrical connection.

AIR OUTLET VENT

in the same colour as the casing, supplied with jet black coated honeycomb grille

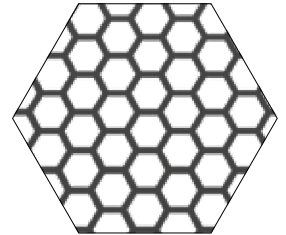

Honeycomb grille

BASE-LINE

XS NET ZERO BASE-LINE WALL-MOUNTED MODEL

DIMENSIONS (in mm)

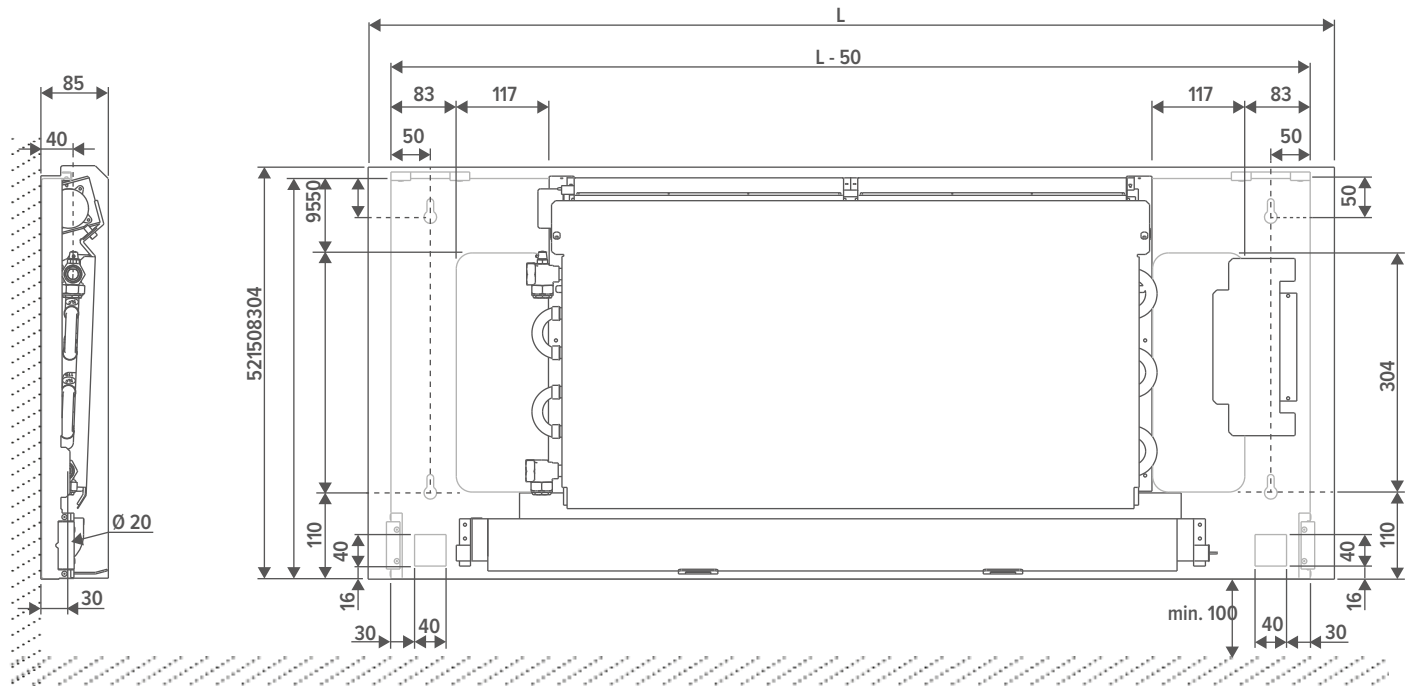

STANDARD DELIVERY

- coated housing in sendzimir galvanised steel plate
- coated back panel made from Sendzimir galvanised sheet steel
- air outlet vent in the same colour as the casing, supplied with jet black coated honeycomb grille
- robust interior made from electro-galvanised steel, premounted to the back panel
- condensation tray with drain (supplied with insulation)
- Low-H₂O heat exchanger
- thermal Activator(s) (tangential mini activator)

COLOURS

Casing Standard colours

- traffic white RAL 9016 (133), soft touch lightly structured satin lacquer
- sandblast grey (001), fine texture metallic lak
- off-black (145), soft touch lightly-textured satin lacquer

Other colours

see Jaga colour chart

Back panel

Standard colour

jet black (104) soft touch lightly structured satin powder coating

CONNECTION

Standard

- hydronic connections on the left
- clamp connector for electric connection 24 VDC, to connect via an external power supply, on the right hand side.

CONNECTION

Hydronic right, electric left. Connection code **R** instead of **L**. No surcharge.

ORDER CODE XS NET ZERO

BNZW 052 086 XS XXX L BL DDD

Control:

- No control system: (leave blank)
- Jaga BMS 0-10V control: D03
- Jaga 3 settings controller: D05

Connection: Standard: L

Optional: R Casing

colour

Length



Order sleeve couplings 3/4" Eurocone separate

XS NET ZERO BASE-LINE WALL-MOUNTED MODEL

HYDRONIC CONNECTION

DIMENSIONS (in mm)

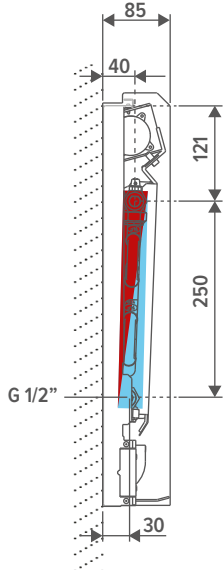

CONNECTION POSSIBILITIES

Eurocone connection set with thermoelectric motor

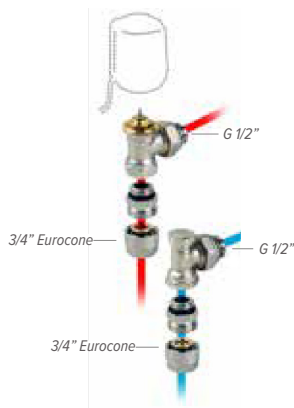

set **289** **KVS 0.8 - default setting in 6 steps**

CODY B18 23 4...	230 VAC
CODY B18 24 4...	24V DC
CODY B18 10 4...	0...10V DC

fill in sleeve coupling code

Sleeve couplings 3/4" Eurocone

PRECISION METAL TUBE		SYNTHETIC OR RPE/ALU	
CODE	Tube Ø	CODE	Tube Ø
112	12/1	612	12/2
114	14/1	614	14/2
115	15/1	616	16/2
116	16/1	618	18/2
118	18/1	619	16/1.5
		620	20/2

Stainless steel xible connections 1/2"



CODE	Length	units
7990 068	200 < 260 mm	2 units

Eurocone connection set with 2 lockshield valves G1/2" 90°



set **288** **KV 1.65**

CODY L01 00 4...

fill in sleeve coupling code

XS NET ZERO BASE-LINE WALL-MOUNTED MODEL

ELECTRICAL CONNECTION

POWER SUPPLIES

 **units are only CE: EN-60335 certified with use of the original power supplies**

Waterproof power supply 24 VDC with waterproof cable gland



- with waterproof swivel nut connector
- in compliance with UL1310 - EN 60950-1 / Class II
- output voltage 24 VDC
- input voltage 100 - 240 VAC
- output current 1.67 A
- output 40 Watts
- dimensions L 14.5 x B 4.5 x H 3.0 cm

CODE	
P (add "P" to the order code)	pre-mountend

ex. BNZW 052 086 XS 133 L BL D03 P

Power supply DIN-rail assembly

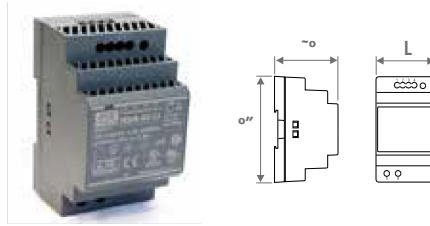

- for DIN-rail or wall mounting in a electrical switchboard
- in compliance with UL60950 / UL508 / EN 60950-1 / TUV EN61558-2-16 / Class II - output voltage 24 VDC
- input voltage 100 - 240 VAC
- screw connection
- LED indicator

CODE	L mm	OUTPUT Watts	OUTPUT CURRENT A
7990 054	3.5	36	1.50
7990 055	5.3	60	2.50
7990 056	7.0	92	3.90
7990 057	10.3	150	6.25

MAXIMUM CABLE LENGTH







Maximum cable length in function of the number of units.
For more information, contact Jaga.

CABLE LENGTH (m)	NUMBER OF BRIZA XS NET ZERO									
	10	20	30	40	50	60	70	80	90	100
XS L086										
1.5 mm ²	38	19	12	9	7	6	5	4	4	3
2.5 mm ²	64	32	21	16	12	10	9	8	7	6
XS L122										
1.5 mm ²	16	8	5	4	3	2	2	2	1	1
2.5 mm ²	27	13	9	6	5	4	3	3	3	2
XS L163										
1.5 mm ²	11	5	3	2	2	1	1	1	1	1
2.5 mm ²	19	9	6	4	3	3	2	2	2	1
XS L199										
1.5 mm ²	8	4	2	2	1	1	1	1		
2.5 mm ²	13	6	4	3	2	2	1	1	1	1

JDPC CONTROLS (OPTIONAL)



CONTROL PANEL

TYPE	POSITION	CONTROL PANEL	EXTERNAL 0-10 V CONTROL	2-PIPE	WATER TEMPERATURE SENSOR	AIR TEMPERATURE SENSOR
BMS 0-10V control (D03)	  	-	✓	✓	✓	-
3 settings controller (D05)	  	✓	-	✓	✓	-



NO JDPC CONTROL SYSTEM

- Upon request for cold or heat, a BMS/home automation system or a thermostat will open the thermoelectric valve.
- Upon request for cold or heat, a BMS/home automation system or a thermostat will send a 0-10 VDC signal. The fan will rotate proportionally to the 0-10 VDC signal.

JAGA BMS 0-10V CONTROL

- When heat or cold is requested, a BMS/home automation system or JAGA thermostat will open the thermoelectric valve. When heat or cold is requested, a BMS/home automation system or JAGA thermostat will send a 0-10V signal. When detecting cold (<18°C) or hot (>28°C) water, the fan will rotate proportionally to the 0-10V signal.

3 SETTINGS CONTROLLER

- When heat or cold is requested, a BMS/home automation system will open the thermoelectric valve. The fan will rotate at a fixed speed once the water has reached the setting of 28°C. The fan will rotate at a fixed speed once the water has reached the setting of 18°C.
- The user manually selects the desired mode via the control panel  /  /  / OFF. The unit can run at 3 speeds. The unit starts at the last selected speed(1, 2 or 3) when the preset water temperature is reached.

XS NET ZERO BASE-LINE WALL MOUNTED MODEL

WHICH CONTROL SYSTEM TO CHOOSE



Wall mounted model

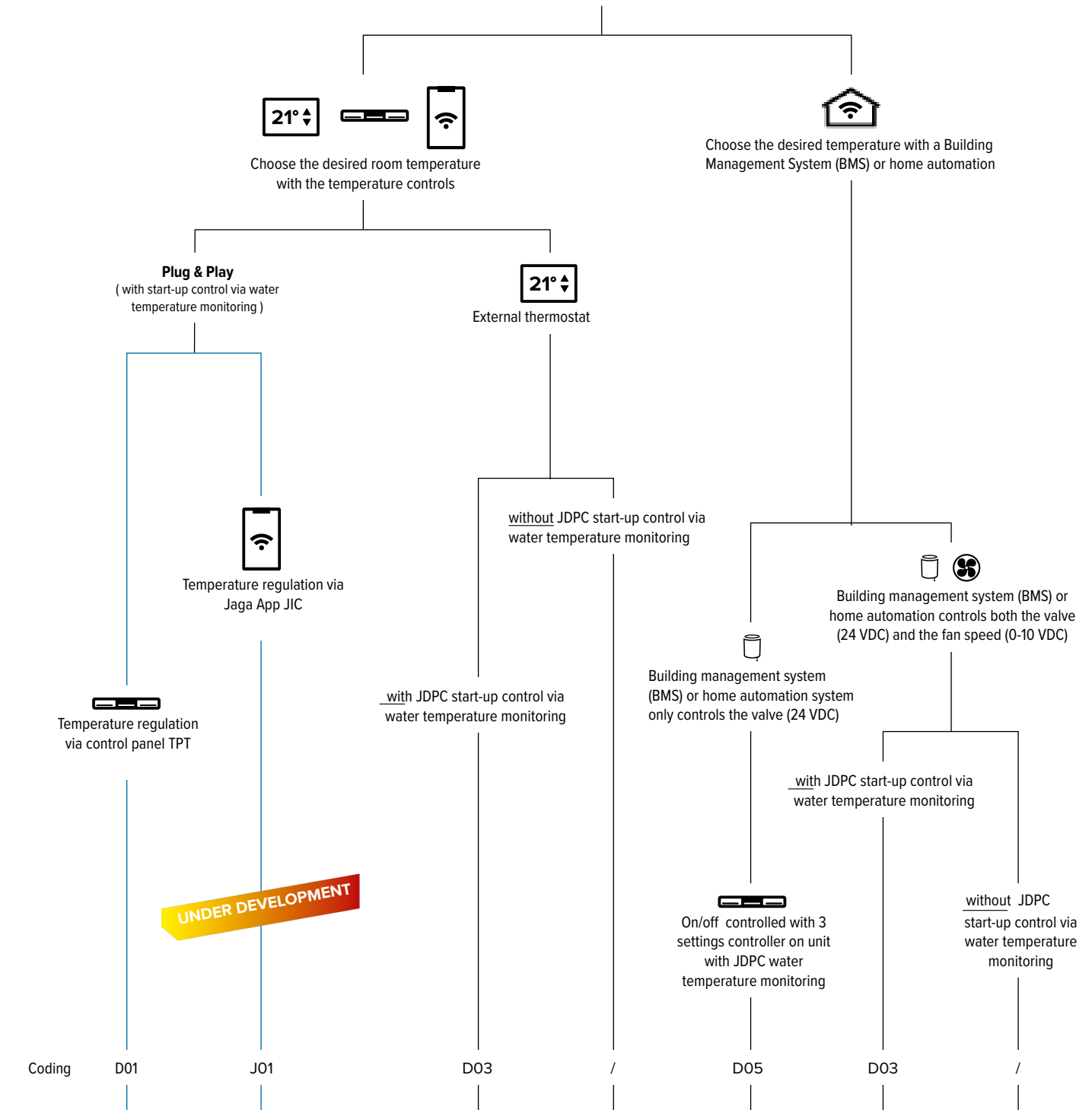

Unit included
 - valve set - power supply - integrated temperature regulation (TPT, App (JIC))
(Order sleeve couplings 3/4" Eurocone separate)

Unit including selected control system

Ordered optionally :

- valve set : set 288 or set 289 - Stainless steel exible connections (in pairs)
- power supply : waterproof swivel nut connector or DIN Rail power supply
- thermostat (0-10V) outside the unit

XS NET ZERO BASE-LINE WALL-MOUNTED MODEL

TECHNICAL TABLE

BNZW	HEIGHT	LENGTH	TYPE	CONTROL VOLTAGE	COOLING <i>(non-condensing) room temperature 27°C</i>			HEATING <i>room temperature 20°C</i>				SOUND PRESSURE LEVEL	AIR FLOW	ENERGY CONSUMPTION	ORDER CODE
	H	L			U	16/18	COOLING TOTAL	PERCEPTIBLE COOLING	35/30	45/40	50/45				
	cm	cm	T	V	Watts	Watts	Watts	Watts	Watts	Watts	Watts	dB(A)	m ³ /h	Watts	
052	086	XS	2	2	18	44	31	45	82	100	109	<20	25	0.5	BNZW 052 086 XS XXX L BL DDD
			4	4	58	142	102	84	152	186	202	<20	34	0.8	
			6	6	91	221	160	122	223	272	295	22.5	47	1.3	
			8	8	117	282	207	161	293	359	389	29.0	61	2.1	
			10	10	137	326	242	201	365	446	484	35.5	77	3.0	
122	XS	2	2	36	89	63	90	164	200	217	<20	26	0.6	BNZW 052 122 XS XXX L BL DDD	
		4	4	115	285	204	167	304	372	403	<20	56	1.3		
		6	6	182	443	321	245	445	545	590	28.0	86	2.7		
		8	8	235	565	414	323	587	718	778	32.5	116	4.6		
		10	10	274	651	483	401	729	893	967	40.0	145	7.1		
163	XS	2	2	56	139	99	141	257	314	341	<20	39	1.1	BNZW 052 163 XS XXX L BL DDD	
		4	4	181	447	320	263	477	584	633	<20	65	2.1		
		6	6	285	695	504	384	699	855	927	27.5	111	4.0		
		8	8	368	886	650	507	921	1127	1222	34.5	148	6.6		
		10	10	430	1022	758	630	1145	1401	1518	42.5	188	10.1		
199	XS	2	2	74	184	130	186	339	415	449	<20	43	1.2	BNZW 052 199 XS XXX L BL DDD	
		4	4	239	589	422	346	629	770	835	20.5	71	2.5		
		6	6	376	917	664	507	921	1127	1222	28.0	131	5.4		
		8	8	485	1168	857	668	1215	1486	1611	36.5	182	9.1		
		10	10	566	1348	1000	831	1509	1847	2002	42.0	206	14.1		

Output measured in accordance with EN 16430

*Noise measurement according to ISO 3741:2010, at a 2-m distance from the unit and with an assumed room attenuation of 8 dB(A)/room volume 100 m³ / reverberation time 0.5 sec.

Casing colour

Connection: Standard: L
Optional: R

Control: No control system: (leave blank)
Jaga BMS 0-10V control: D03
Jaga 3 settings controller: D05



XS Net Zero BASE-
Line H52 x L122
Traffic white (133)

- 🌡️ 16/18/27 °C 566 Watts (10 V)
- 🌡️ 7/12/27 °C 1348 Watts (10 V)
- 🌡️ 35/30/20 °C 831 Watts (10 V)

XS NET ZERO BASE-LINE CEILING MOUNTED MODEL

ROBUST INTERIOR

made from electro-galvanised steel, premounted to the back panel

THERMAL ACTIVATOR(S) (tangential mini activator)

Tangential activators with aluminium fins are provided with ball bearings and resin-coated EPDM vibration damping built-in EC motor for a much lower energy consumption and a longer service life

HYDRONIC CONNECTIONS on the left

CONDENSATE TRAY with outlet spigot \varnothing 2 cm from electrolytic galvanized steel plate dark grey lacquered in RAL 7024

COATED HOUSING in sendzimir galvanised steel plate



Traffic white 133



Sandblast grey 001

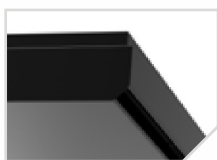

OFF-BLACK 145

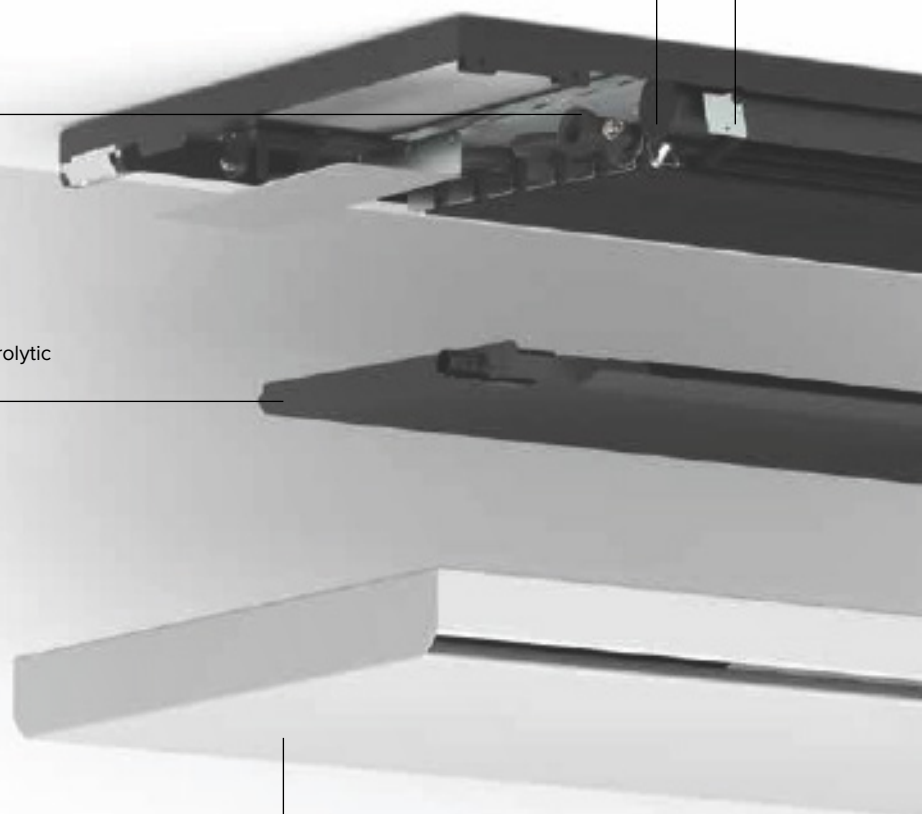

BACK PANEL (jet black 104)
for simple installation. The panel is supplied with recesses for water-side and electrical connection.

ELECTRICAL CONNECTION
clamp connector for electric connection 24 VDC, to connect
via an external power supply, on the right hand side.

LOW-H₂O HEAT EXCHANGER
The Low-H₂O heat exchanger is the hyper-reactive, aluminium
and copper motor of the ecological products



AIR OUTLET VENT
in the same colour as the casing,
Supplied with jet black coated honeycomb grille

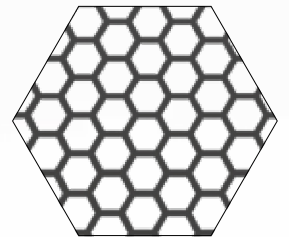

Honeycomb grille

BASE-LINE

XS NET ZERO BASE-LINE CEILING MOUNTED MODEL

DIMENSIONS (in mm)

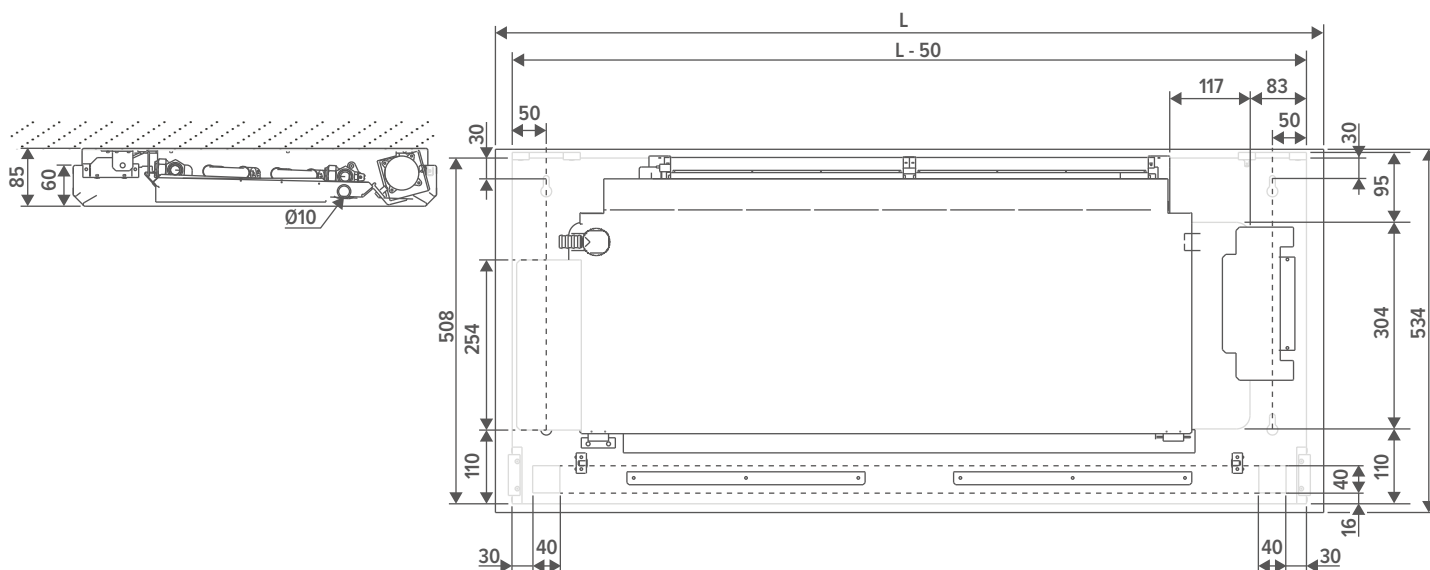

STANDARD DELIVERY

- coated housing in sendzimir galvanised steel plate
- coated back panel made from Sendzimir galvanised sheet steel
- air outlet vent in the same colour as the casing, supplied with jet black coated honeycomb grille
- robust interior made from electro-galvanised steel, premounted to the back panel
- condensation tray with drain made from electro-galvanised steel sheet (supplied with insulation)
- Low-H₂O heat exchanger
- thermal Activator(s) (tangential mini activator)

COLOURS

Casing

Standard colours

- traffic white RAL 9016 (133), soft touch lightly structured satin lacquer
- sandblast grey (001), fine texture metallic lak
- off-black (145), soft touch lightly-textured satin lacquer

Other colours

see colour chart

Back panel

Standard colour

- jet black (104) soft touch lightly structured satin powder coating
- traffic white RAL 9016 (133), soft touch lightly structured satin lacquer

CONNECTION

Standard

- hydronic connections on the left
- clamp connector for electric connection 24 VDC, to connect via an external power supply, on the right hand side.

Optional

Hydronic right, electric left. Connection code **R** instead of **L**. No surcharge.

ORDER CODE XS NET ZERO

BNZC 053 086 XS XXX X L BL DDD

Control:

- No control system: (leave blank)
- Jaga BMS 0-10V control: D03
- Jaga On/off: D07

Connection: Standard: L

Optional: R

Back panel colour:

- Jet black (104) : B
- Traffic white (133): W

Casing colour

Length

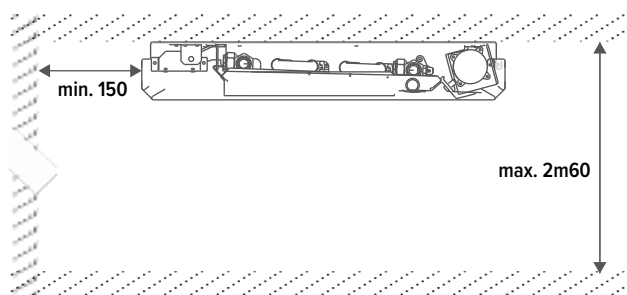

XS NET ZERO BASE-LINE CEILING MOUNTED MODEL

HYDRONIC CONNECTION

DIMENSIONS (in mm)

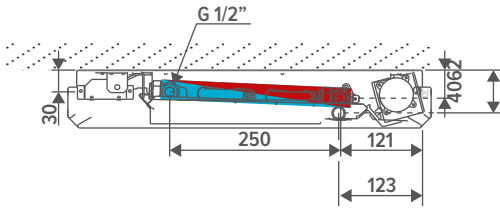

CONNECTION POSSIBILITIES

Eurocone connection set with thermoelectric motor

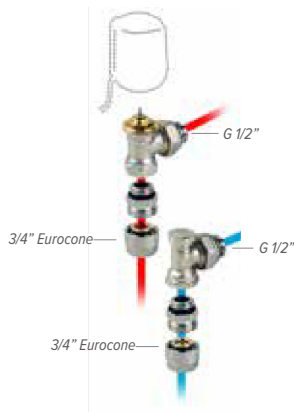

set
289

KVS 0.8 - default setting in 6 steps

CODY B18 23 4...	230 VAC
CODY B18 24 4...	24V DC
CODY B18 10 4...	0...10V DC

fill in sleeve coupling code

Eurocone connection set with 2 lockshield valves G1/2" 90°

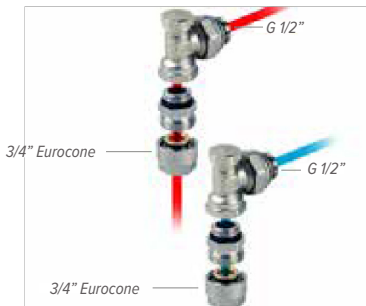

set
288

KV 1.65

CODY L01 00 4...

fill in sleeve coupling code

Sleeve couplings 3/4" Eurocone

PRECISION METAL TUBE		SYNTHETIC OR RPE/ALU	
CODE	Tube Ø	CODE	Tube Ø
112	12/1	612	12/2
114	14/1	614	14/2
115	15/1	616	16/2
116	16/1	618	18/2
118	18/1	619	16/1.5
		620	20/2

Stainless steel flexible connections 1/2"



CODE
7990 068

Length
200 < 260 mm

2 units

CONDENSATION SOLUTIONS

Condensate pump



CODE

C (add "C" to the order code) pre-mountend

ex. BNZC 052 086 XS 133 B L BL D03 **C**



Required for Deep Cooling

XS NET ZERO BASE-LINE CEILING MOUNTED MODEL

ELECTRICAL CONNECTION

POWER SUPPLIES

 **units are only CE: EN-60335 certified with use of the original power supplies**

Waterproof power supply 24 VDC with waterproof cable gland



- with waterproof swivel nut connector
- in compliance with UL1310 - EN 60950-1 / Class II
- output voltage 24 VDC
- input voltage 100 - 240 VAC
- output current 1.67 A
- output 40 Watts
- dimensions L 14.5 x B 4.5 x H 3.0 cm

CODE P (add "P" to the order code) pre-mountend

ex. BNZC 052 086 XS 133 B L BL D03 **P**

Power supply DIN-rail assembly

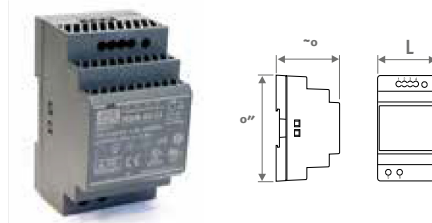

- for DIN-rail or wall mounting in a electrical switchboard
- in compliance with UL60950 / UL508 / EN 60950-1 / TUV EN61558-2-16 / Class II - output voltage 24 VDC
- input voltage 100 - 240 VAC
- screw connection
- LED indicator





CODE	L mm	OUTPUT Watts	OUTPUT CURRENT A
7990 054	3.5	36	1.50
7990 055	5.3	60	2.50
7990 056	7.0	92	3.90
7990 057	10.3	150	6.25

CABLE LENGTH (m)	NUMBER OF BRIZA XS NET ZERO									
	10	20	30	40	50	60	70	80	90	100
BRIZA XS L086										
1.5 mm ²	38	19	12	9	7	6	5	4	4	3
2.5 mm ²	64	32	21	16	12	10	9	8	7	6
BRIZA XS L122										
1.5 mm ²	16	8	5	4	3	2	2	2	1	1
2.5 mm ²	27	13	9	6	5	4	3	3	3	2
BRIZA XS L163										
1.5 mm ²	11	5	3	2	2	1	1	1	1	1
2.5 mm ²	19	9	6	4	3	3	2	2	2	1
BRIZA XS L199										
1.5 mm ²	8	4	2	2	1	1	1	1	1	1
2.5 mm ²	13	6	4	3	2	2	1	1	1	1

JDPC CONTROLS (OPTIONAL)

JDPC (JAGA DYNAMIC PRODUCT CONTROLLER)





TYPE	POSITION	CONTROL PANEL	EXTERNAL 0-10 V CONTROL	2-PIPE	WATER TEMPERATURE SENSOR	AIR TEMPERATURE SENSOR
Jaga BMS 0-10V control (D03)	  	-	✓	✓	✓	-
Jaga On/off (D07)	  	✓	-	✓	✓	-

NO JAGA JDPC CONTROL SYSTEM

- Upon request for cold or heat, a BMS/home automation system or a JAGA thermostat will open the thermoelectric valve.
- Upon request for cold or heat, a BMS/home automation system or a JAGA thermostat will send a 0-10 VDC signal. The fan will rotate proportionally to the 0-10 VDC signal. **JAGA BMS 0-10V CONTROL**

- When heat or cold is requested, a BMS/home automation system or thermostat will open the thermoelectric valve. When heat or cold is requested, a BMS/home automation system or JAGA thermostat will send a 1-10V signal. When detecting cold (<18°C) or hot (>28°C) water, the fan will rotate proportionally to the 0-10V signal.

JAGA ON/OFF

- When heat or cold is requested, a BMS/home automation system will open the thermoelectric valve. The fan will rotate at a fixed speed once the water has reached the setting of 28°C. The fan will rotate at a fixed speed once the water has reached the setting of 18°C.
- The user manually selects the desired mode via the control panel  /  /  / OFF. The unit can run at 3 speeds. The unit starts at the last selected speed(1, 2 or 3) when the preset water temperature is reached.

XS NET ZERO BASE-LINE CEILING MOUNTED MODEL

WHICH CONTROL SYSTEM TO CHOOSE

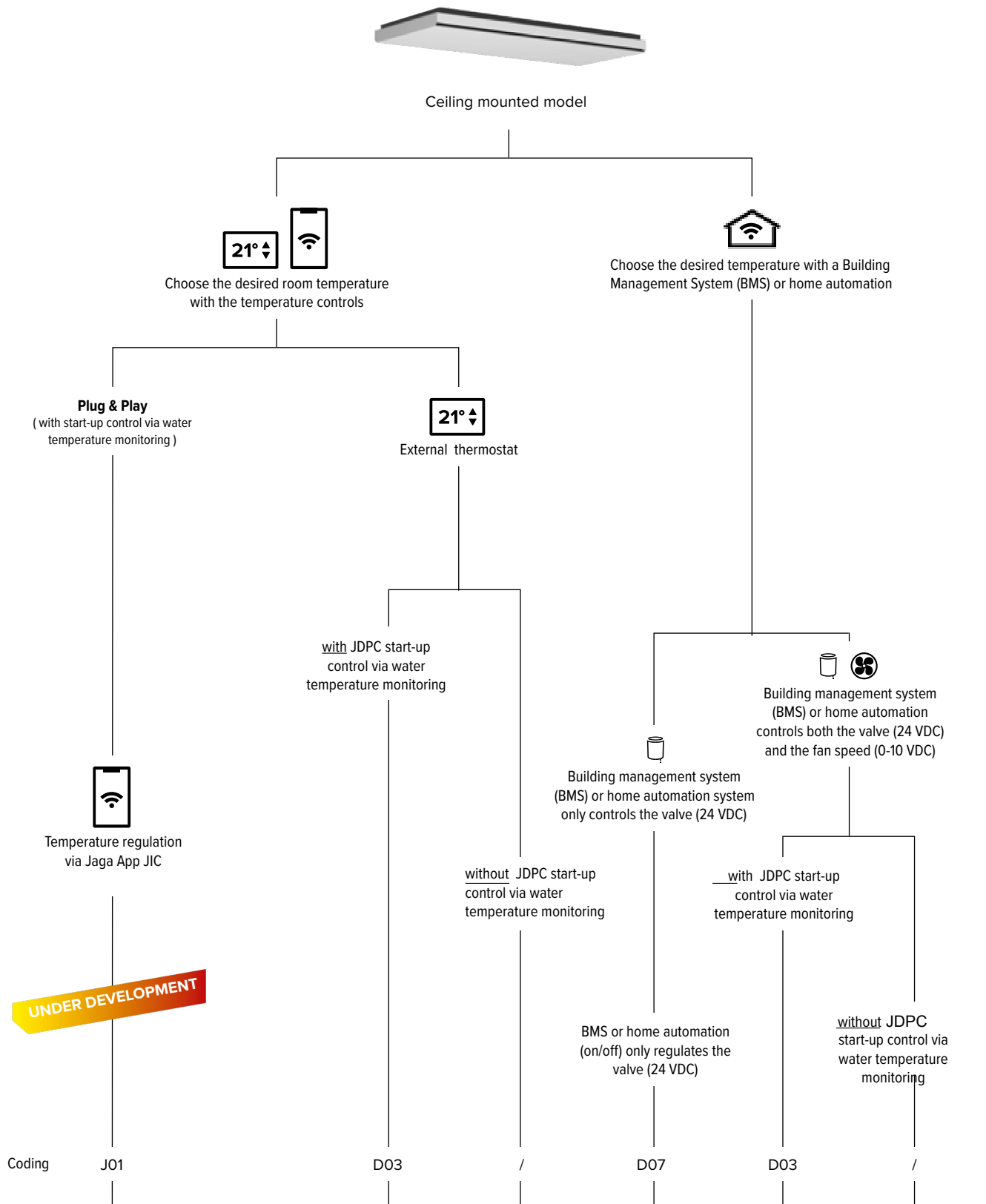

Unit included

- valve set
- power supply
- integrated temperature regulation(App JIC)

*(Order sleeve couplings 3/4" Eurocone separate)
Condensing cooling with a ceiling-mounted model?
Add a condensate pump to your order!*

Unit including selected control system

Ordered optionally

- valve set: set 288 or set 289
- Stainless steel flexible connections (in pairs)
- power supply: waterproof swivel nut connector or DIN Rail power supply
- thermostat (0-10V) outside the unit
- condensate pump (Condensing cooling)

XS NET ZERO BASE-LINE CEILING MOUNTED MODEL

TECHNICAL TABLE

BNZC	WIDTH	LENGTH	TYPE	CONTROL VOLTAGE	COOLING	COOLING TOTAL	PERCEPTIBLE COOLING	HEATING				SOUND PRESSURE LEVEL	AIR FLOW	ENERGY CONSUMPTION	ORDER CODE
	B	L			(non-condensing)	room temperature 27°C	room temperature 27°C	room temperature 27°C	35/30	45/40	50/45				
	cm	cm		U	16/18	7/12	7/12					dB(A)	m ³ /h	Watts	
053	086	XS	2	18	44	31	45	82	100	109	<20	25	0.5	BNZC 053 086 XS XXX X L BL DDD	
			4	58	142	102	84	152	186	202	<20	34	0.8		
			6	91	221	160	122	223	272	295	22.5	47	1.3		
			8	117	282	207	161	293	359	389	29.0	61	2.1		
			10	137	326	242	201	365	446	484	35.5	77	3.0		
122	XS	2	36	89	63	90	164	200	217	<20	26	0.6	BNZC 053 122 XS XXX X L BL DDD		
		4	115	285	204	167	304	372	403	<20	56	1.3			
		6	182	443	321	245	445	545	590	28.0	86	2.7			
		8	235	565	414	323	587	718	778	32.5	116	4.6			
		10	274	651	483	401	729	893	967	40.0	145	7.1			
163	XS	2	56	139	99	141	257	314	341	<20	39	1.1	BNZC 053 163 XS XXX X L BL DDD		
		4	181	447	320	263	477	584	633	<20	65	2.1			
		6	285	695	504	384	699	855	927	27.5	111	4.0			
		8	368	886	650	507	921	1127	1222	34.5	148	6.6			
		10	430	1022	758	630	1145	1401	1518	42.5	188	10.1			
199	XS	2	74	184	130	186	339	415	449	<20	43	1.2	BNZC 053 199 XS XXX X L BL DDD		
		4	239	589	422	346	629	770	835	20.5	71	2.5			
		6	376	917	664	507	921	1127	1222	28.0	131	5.4			
		8	485	1168	857	668	1215	1486	1611	36.5	182	9.1			
		10	566	1348	1000	831	1509	1847	2002	42.0	206	14.1			

Output measured in accordance with EN 16430

*Noise measurement according to ISO 3741:2010, at a 2-m distance from the unit and with an assumed room attenuation of 8 dB(A)/room volume 100 m³ / reverberation time 0.5 sec.

Casing colour |
 Back panel colour |
 Connection: Standard: L
 Optional: R |
 Control: No control system: (leave blank)
 Jaga BMS 0-10V control: D03
 Jaga On/off: D07

XS Net Zero
BASE-Line B53 x L199
Off-white (102)

- 16/18/27 °C 566 Watts (10 V)
- 7/12/27 °C 1348 Watts (10 V)
- 35/30/20 °C 831 Watts (10 V)

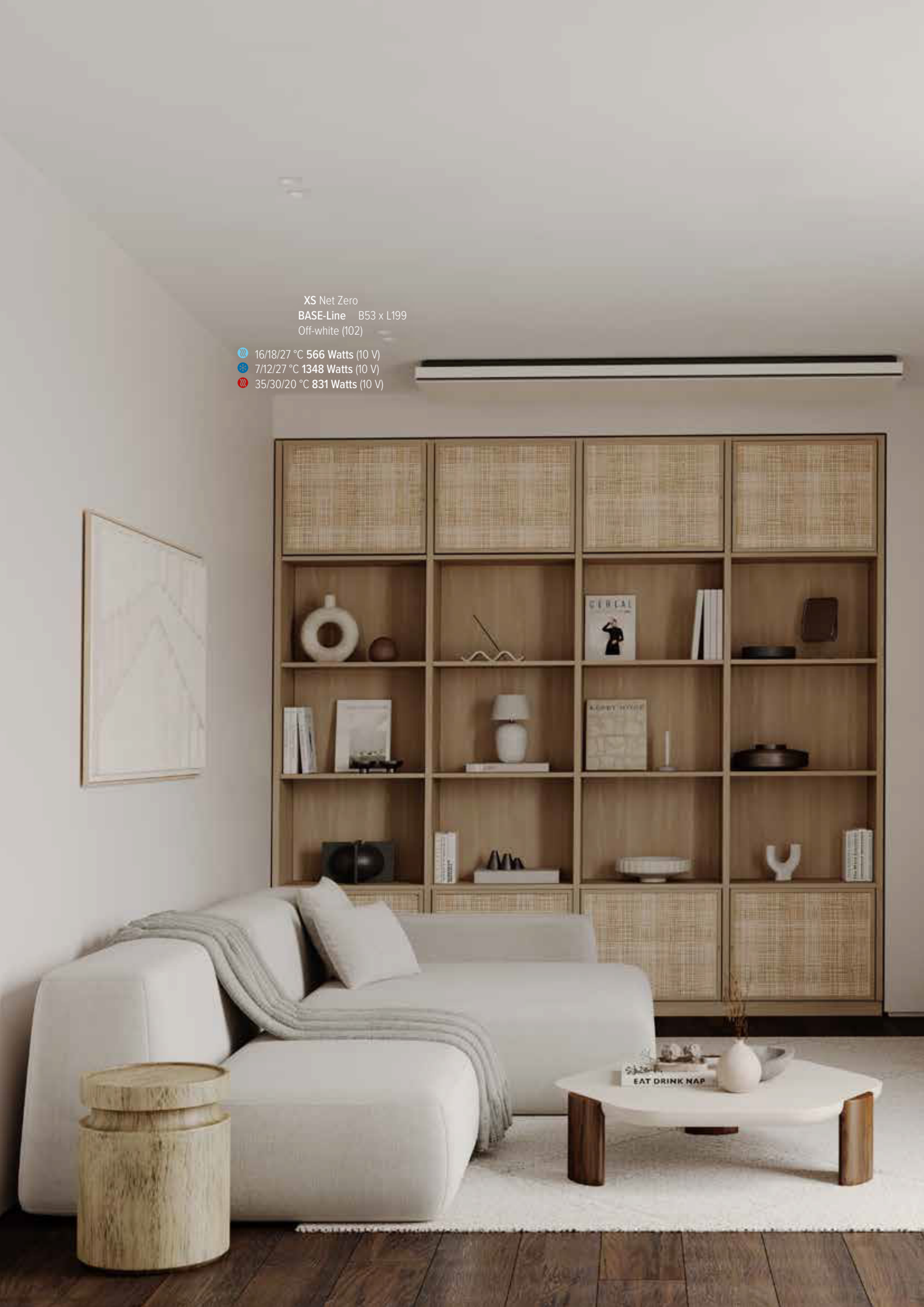

XS NET ZERO BASE-LINE

EXTERNAL JAGA THERMOSTAT

JRT-100 TB
BLACK



8751 050019

JRT-100 TW
WHITE



8751 050017

JRT-100



8751 050012

JRT-200



8751 050013

RDG 160T



8751 050009

RDG264KN



8751 050018

	JRT-100 TB / TW	JRT-100	JRT-200	RDG 160T	RDG264KN
POWER SUPPLY					
supply voltage	24V DC	24V DC	24V DC	24V DC	24V DC
OUTPUT / INPUT VOLTAGE					
valve 24V DC contact	2 (NO)	2 (NO)	-	-	-
potential-free contact	-	-	2 (NO)	3 (NO)	3 (NO)
input from keycard	-	-	✓	✓	✓
input from window contact	-	-	-	✓	✓
fan (0 - 10 V DC)	max. +/- 10 mA	max. +/- 10 mA	max. +/- 10 mA	max. +/- 5 mA	max. +/- 5 mA
manual 3-position speed controller	✓	✓	✓	✓	✓
automatic mode	✓	✓	✓	✓	✓
APPLICATIONS					
2-pipe					
manually (H/C)	✓	✓	✓	✓	✓
auto (H/C) - water temperature sensor necessary	-	-	-	✓	✓
4-pipe					
manually (H/C)	✓	✓	✓	✓	✓
auto (H/C)	✓	✓	✓	✓	✓
DIMENSIONS					
for wall mounting	-	-	✓	✓	✓
for recessed-mounting	✓	✓	optional	optional	optional
POSITION					
LCD display with backlight	-	✓	✓	✓	✓
LCD touch screen with backlight	✓	-	-	-	-
protection category IP20	-	-	-	-	-
protection category IP30	✓	✓	✓	✓	✓
Integrated CO2-sensor	-	-	-	-	✓
humidity sensor	-	-	-	-	✓
FEATURES					
programmable time zones	✓	✓	✓	✓	✓
control via Wi-Fi (smartphone app)	✓	-	-	-	-
fan start delay	-	-	-	✓	✓
continuous fan speed	-	-	-	✓	✓
temperature sensor 80 cm	✓	✓	optional	optional	optional

XS NET ZERO BASE-LINE

CORRECTION FACTORS

The indicated outputs at ΔT 50 are exact values measured in accordance with EN16430. This table provides a calculated value using an average correction factor for all other ΔT outputs, valid for all dimensions.

Click netzero.jaga.com/ to download the calculation tools with the exact outputs. The online calculation tools are kept up to date with the most recent data. Minor output differences between printed tables and the different online calculation tools are therefore completely normal and within the margins of tolerance imposed by the standard.

AVERAGE CORRECTION FACTORS DYNAMIC PRODUCTS - 75/65/20°C

room temperature: 20°C

Average N-value: 1.00

	TR	65	60	55	50	45	40	35	30	25
TA										
75		1.00	0.95	0.89	0.83	0.76	0.69	0.62	0.53	0.42
70		0.95	0.90	0.84	0.79	0.72	0.66	0.58	0.50	0.39
65			0.85	0.80	0.74	0.68	0.62	0.55	0.47	0.37
60				0.75	0.70	0.64	0.58	0.51	0.43	0.34
55					0.65	0.60	0.54	0.47	0.40	0.31
50						0.55	0.49	0.43	0.37	0.28
45							0.45	0.39	0.33	0.25
40								0.35	0.29	0.22
35									0.25	0.18
30										0.14

room temperature: 24°C

Average N-value: 1.00

	TR	65	60	55	50	45	40	35	30	25
TA										
75		0.92	0.86	0.81	0.74	0.68	0.61	0.52	0.42	0.26
70		0.87	0.82	0.76	0.70	0.64	0.57	0.49	0.39	0.24
65			0.77	0.72	0.66	0.60	0.53	0.46	0.37	0.22
60				0.67	0.62	0.56	0.49	0.42	0.34	0.20
55					0.57	0.52	0.46	0.39	0.31	0.18
50						0.47	0.41	0.35	0.27	0.15
45							0.37	0.31	0.24	0.13
40								0.27	0.20	0.11
35									0.17	0.08
30										0.06

XS NET ZERO BASE-LINE

PRESSURE DROP

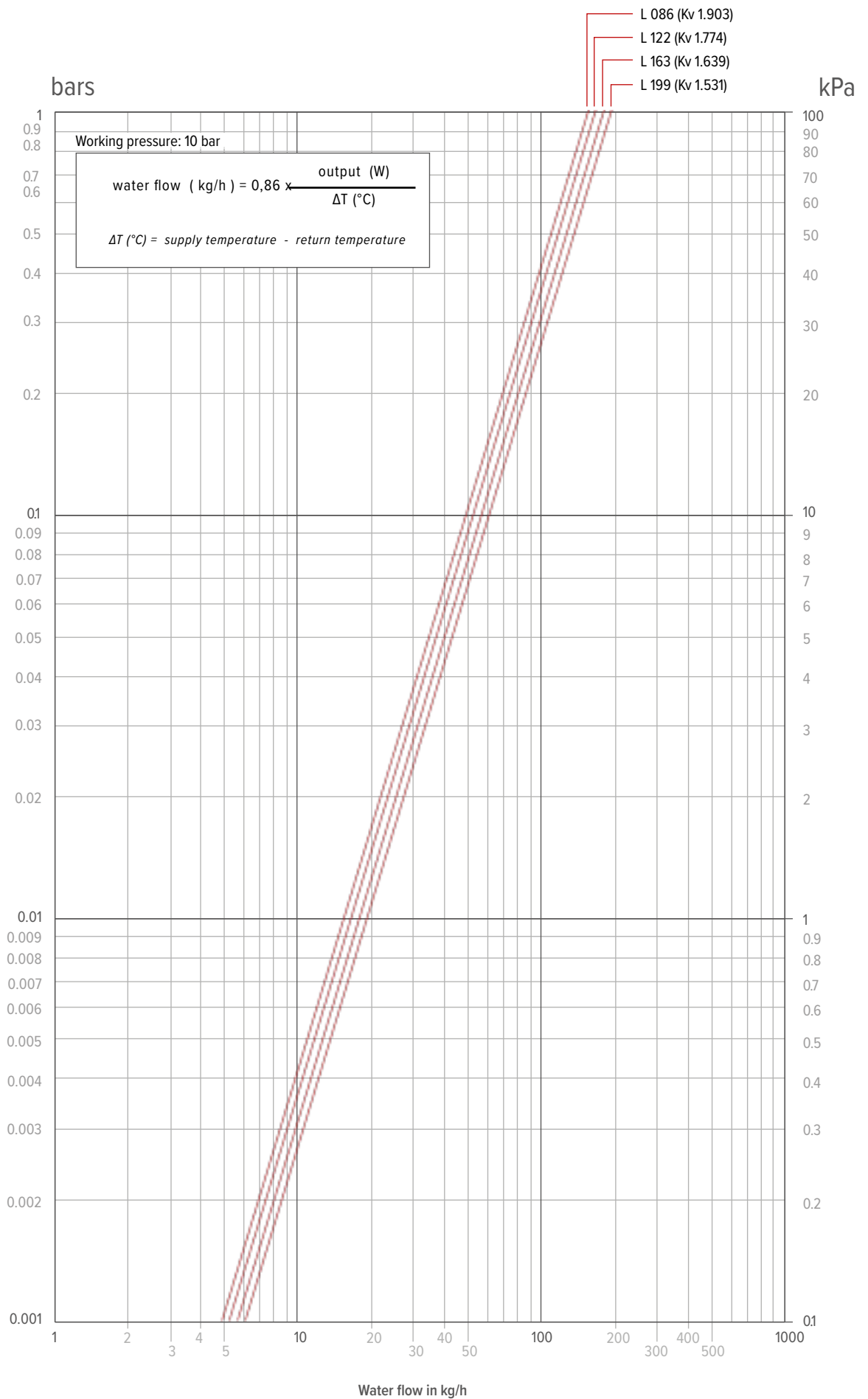

versatile

NET ZERO

www.versatile.ie

+353 (0) 46 902 9444

info@versatile.ie

Beechmount Home Park, Navan, Co. Meath, Ireland